

# Technics

Frequency Generator Servo  
Automatic Turntable System

## SL-235/SL-235A Operating instructions



The model number of this product may be found on the back of the unit, and the serial number, on the bottom of the unit. Please note the model and serial numbers of this unit in the space provided and retain this booklet as a permanent record of your purchase to aid identification in the event of theft.

MODEL NUMBER

---

SERIAL NUMBER

---

Before operating this set, please read these instructions completely

We want to thank you for selecting the SL-235/SL-235A.  
 For optimum performance, we recommend that you read these instructions carefully.

**These operating instructions cover both SL-235 and SL-235A**

## Parts identification

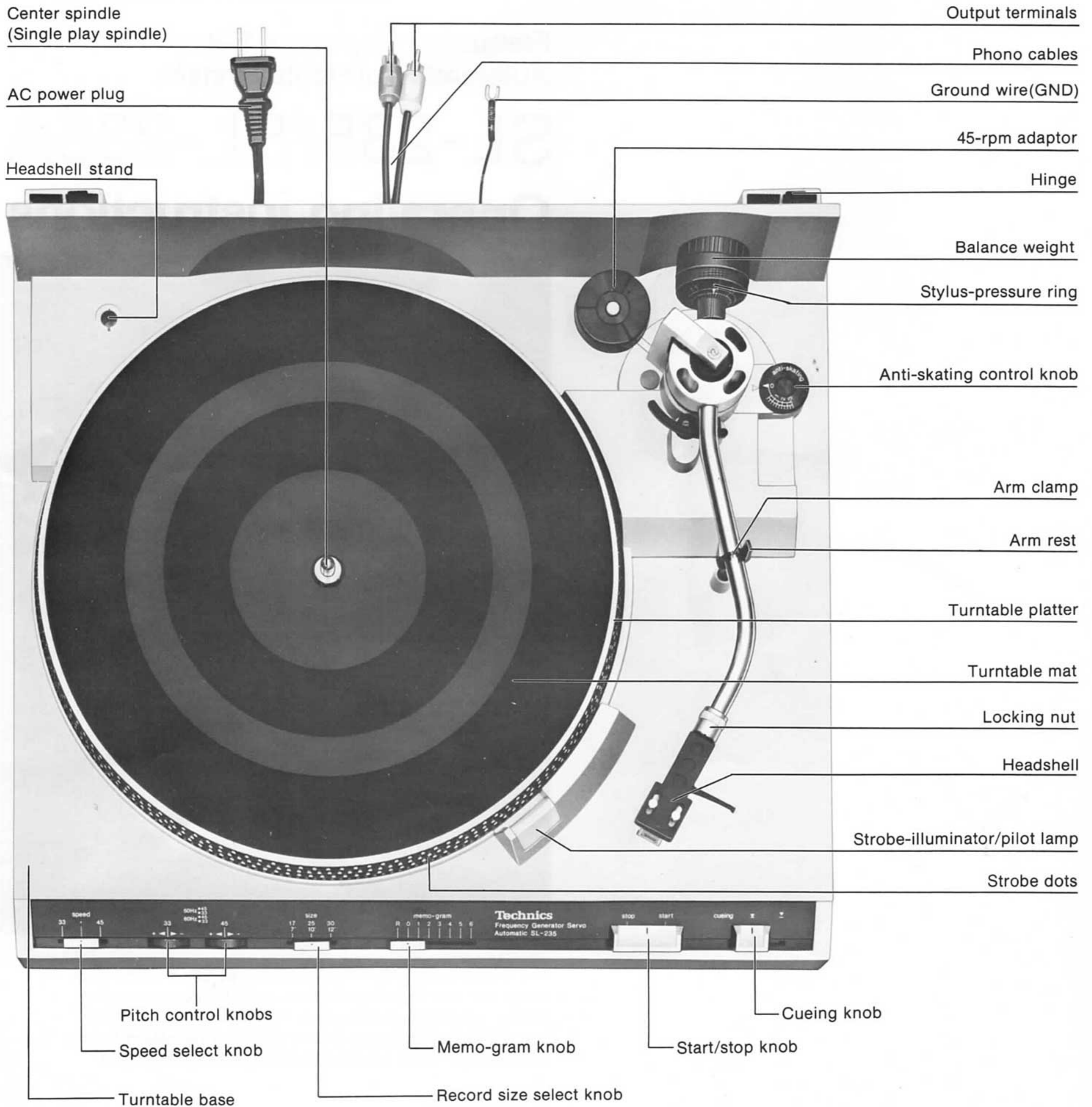

Fig. 1

**“Warning: To prevent fire or shock hazard,  
 do not expose this appliance to rain or moisture.”**

## Before use

The operating instructions are commonly applicable to sets with cartridge (SL-235A) and without cartridge (SL-235), so please refer to the following notes for further information. For sets without cartridge, the cartridge section of the specifications may be ignored.

### Checklist of parts

Turntable unit .....	1
Turntable platter .....	1
Turntable mat .....	1
Dust cover .....	1
Multiple-play spindle .....	1
Single-play spindle .....	1
45-rpm adaptor (for multiple-play).....	1
45-rpm adaptor (for single-play).....	1
Balance weight .....	1
Headshell .....	1
(Overhang gauge .....	1)
(for the unit without cartridge)	

## Assembly and set-up

### Caution:

Never connect the AC power plug before assembly has been completed.  
Attach the dust cover last, so that assembly and adjustments can be made most conveniently.

### 1 Installation of the turntable platter

1. Place the turntable platter on the center spindle.
2. Attach the belt to the capstan using the ribbon as shown in the picture. (See Fig. 2.)  
And then, remove the ribbon.
3. Place the turntable mat on the platter.

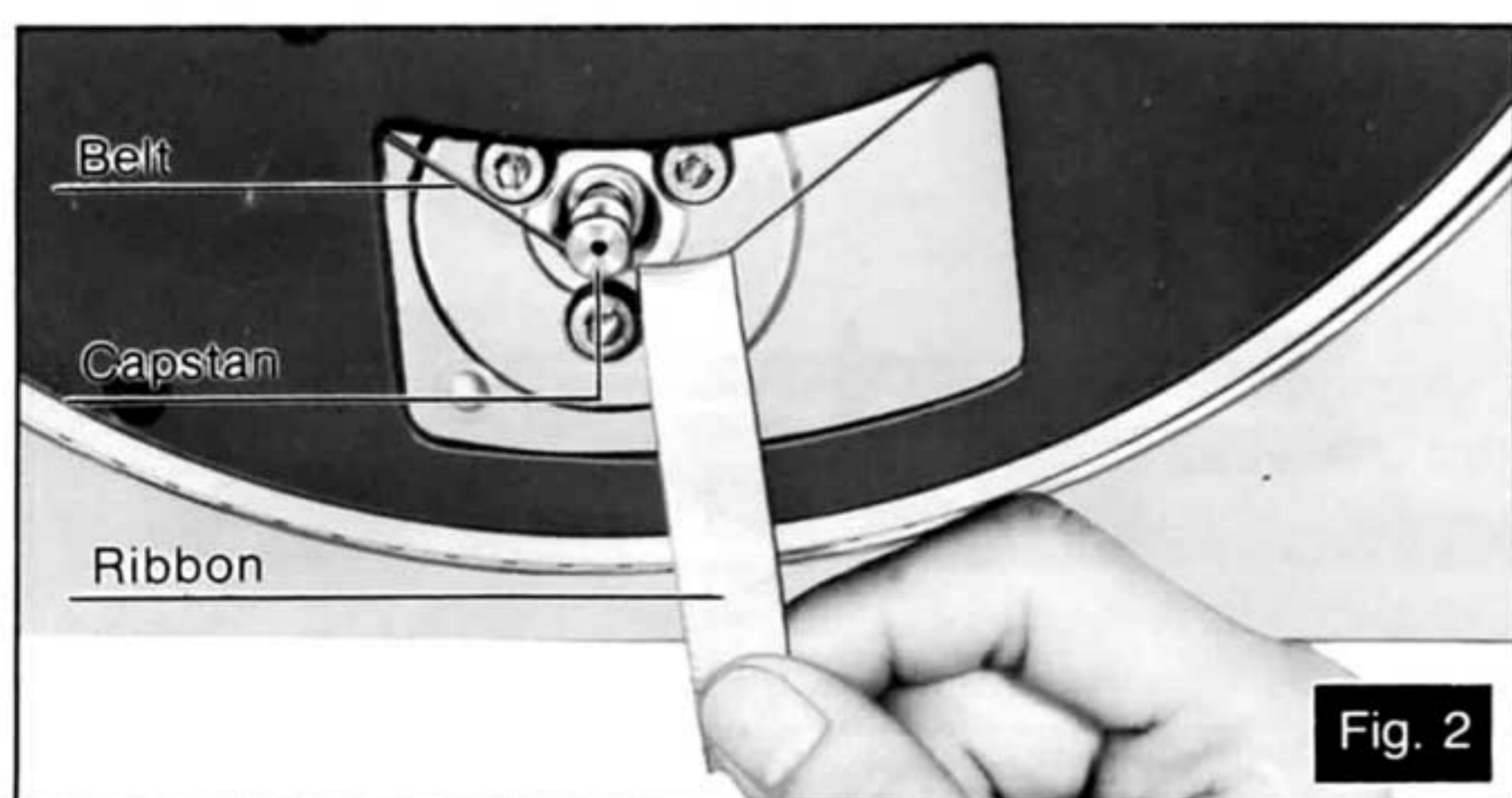

### 2 Installation of the cartridge (for SL-235)

Please refer to the following when installing a cartridge. The tonearm of this model has been designed to accommodate a wide range of differences in cartridge geometry, so that the majority of phonograph cartridges in use today may be mounted for proper overhang and proper tracking with a stack of up to six records on the platter. However, the owner should check before selecting a cartridge to make sure that it is compatible. Generally, if cartridge height is greater than 20 mm, it will interfere with tracking on the last record of a stack of six, limiting the maximum capacity to five records. If cartridge height, on the other hand, is less than 15 mm spacers should be added to the cartridge mounting plate in the headshell. (See Fig.3.)

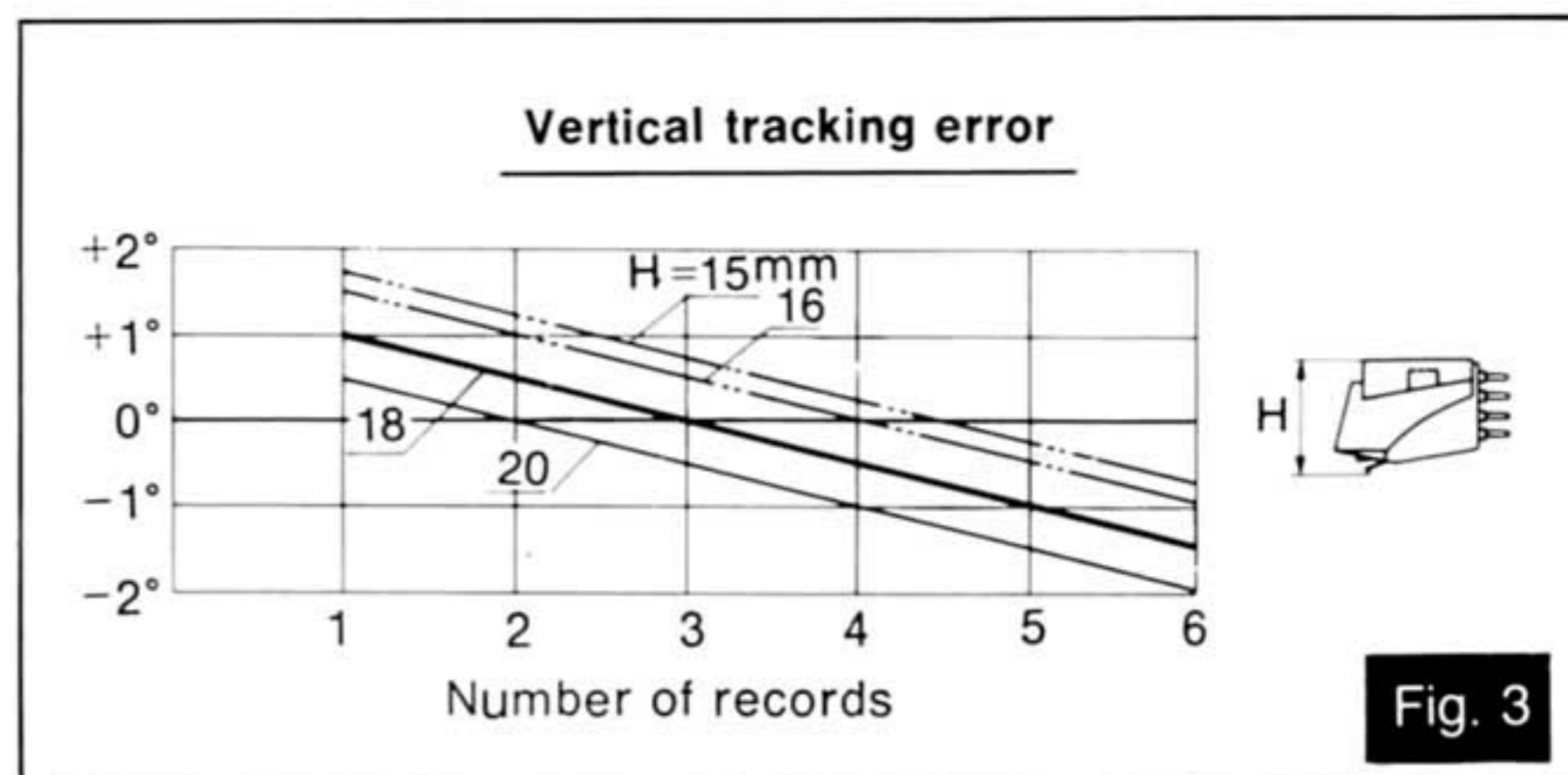

1. Connect the lead wires to the cartridge terminals.  
The terminals of most cartridges are color coded.  
Connect each lead wire to the terminal of the same color.  
White (L+) ..... Left channel (+)  
Blue (L-) ..... Left channel (-)  
Red (R+) ..... Right channel (+)  
Green (R-) ..... Right channel (-)
2. Install a cartridge to the headshell, and tighten it with screws provided with the cartridge. (See Fig. 4.)

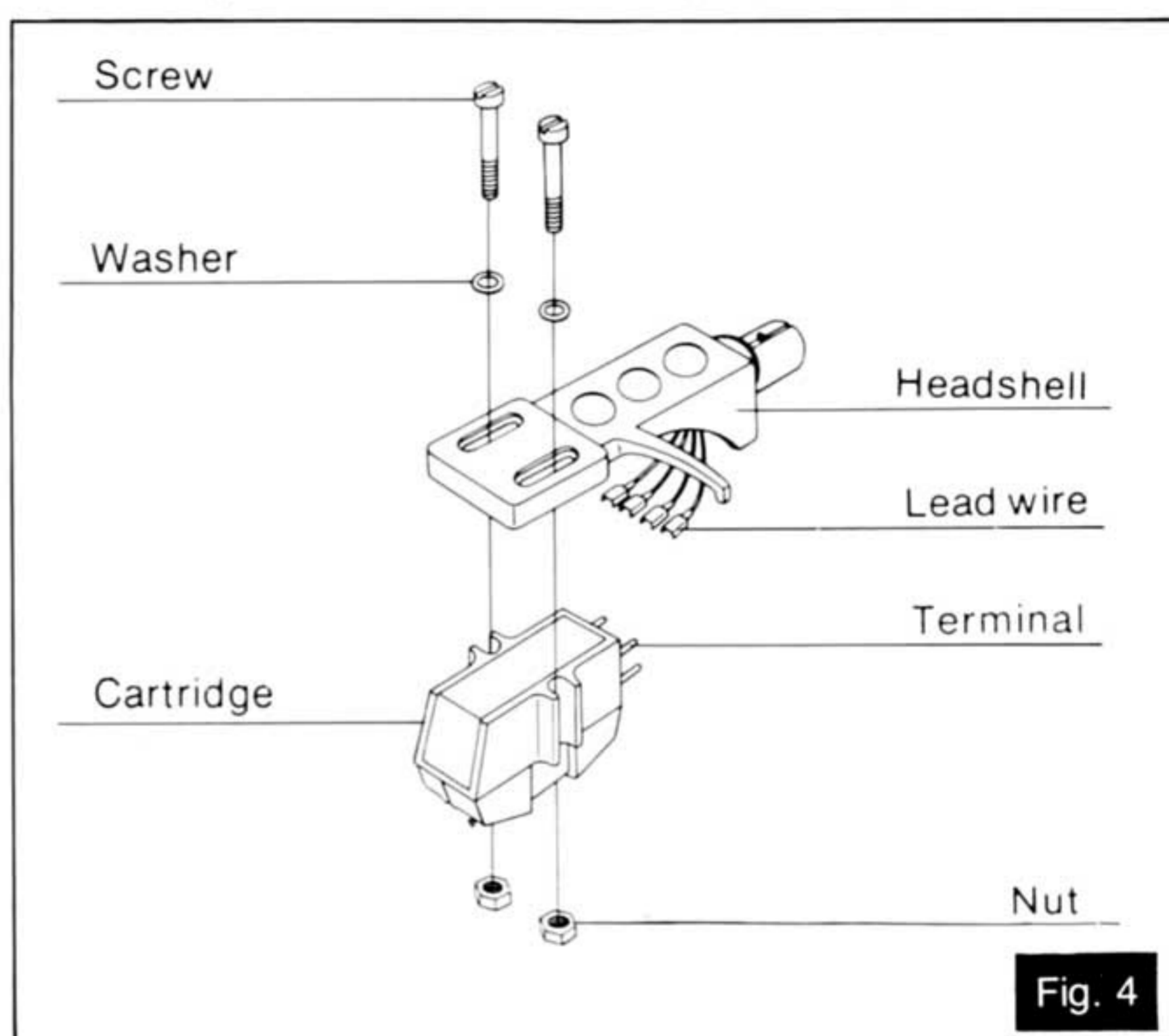

### Adjustment of overhang

#### A) For the unit with overhang gauge (SL-235)

1. Insert the headshell into the gauge. (See Fig. 5-1.)
2. Loosen the mounting screws and move the cartridge forward or backward until the stylus tip lines up with the edge of the gauge.
3. Tighten the screws without moving the cartridge.

#### Note:

- Your cartridge is now adjusted for lowest tracking error and minimum distortion.
- This gauge is exclusively designed for this tonearm.

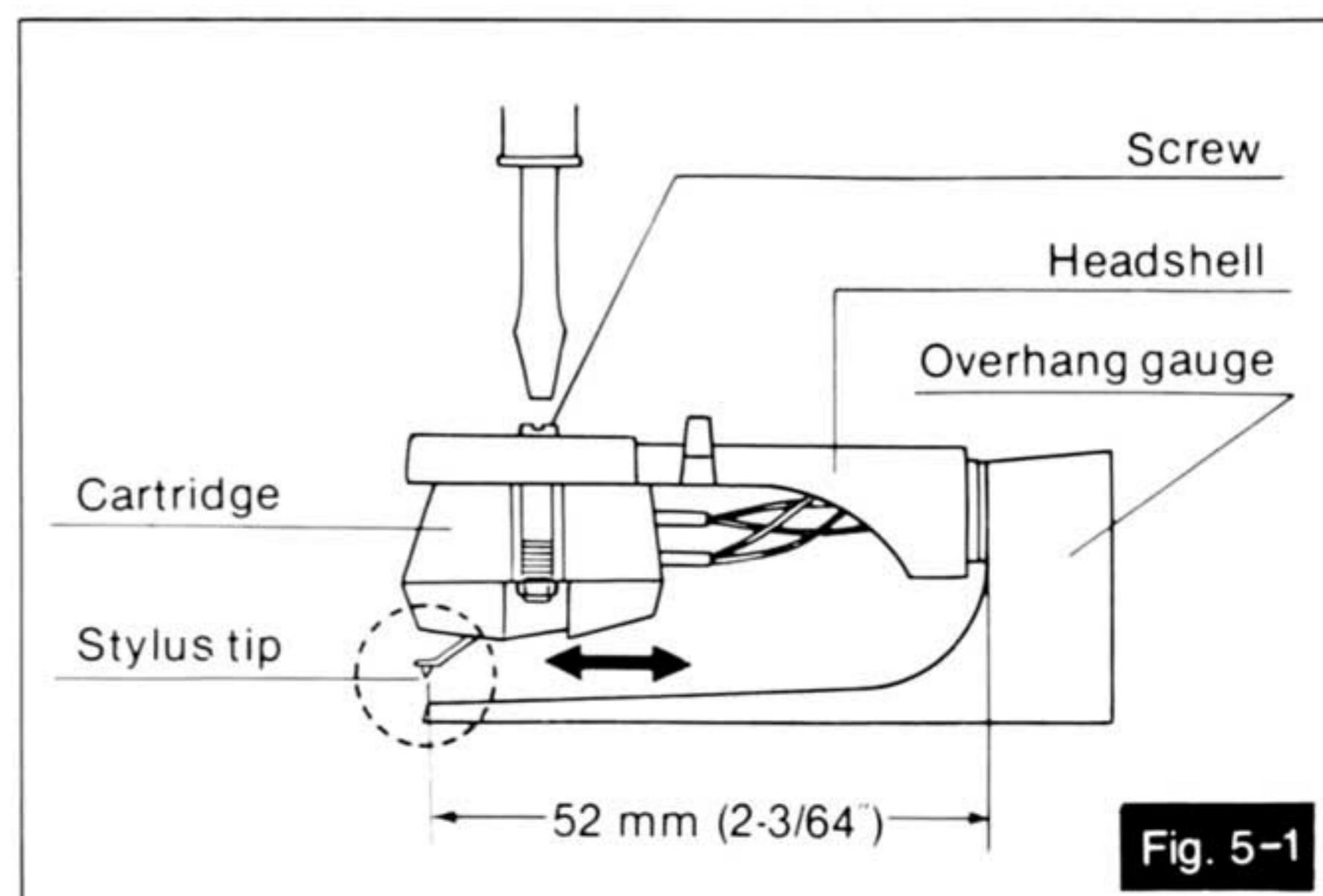

### B) For the unit without overhang gauge (SL-235A)

SL-235A has already been adjusted at the factory. But if it is necessary to adjust for any reason, adjust as follows:

- The overhang of this unit is 15 mm.
- Loosen the screws and move the cartridge forward or backward until the distance between the stylus tip and the plug becomes 52 mm (2-3/64") as shown in the picture. (See Fig. 5-2.)
- Tighten the screws without moving the cartridge.

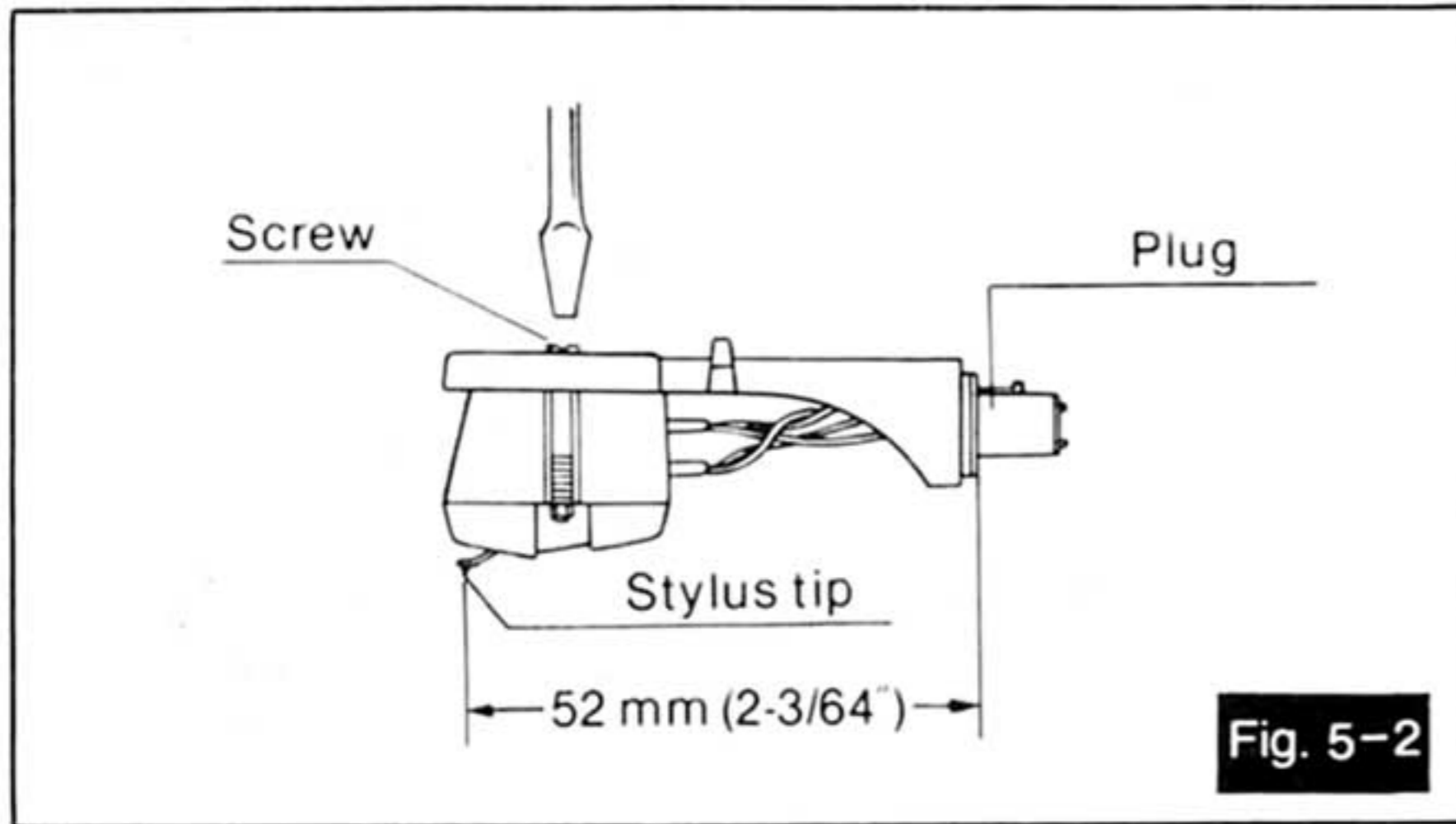

### ③ Installation of the headshell/cartridge assembly (See Fig. 6.)

Insert the headshell/cartridge assembly into the front end of the tubular arm, and turn the locking nut clockwise (in the direction shown by the arrow "A"), with the headshell/cartridge assembly firmly held horizontally.

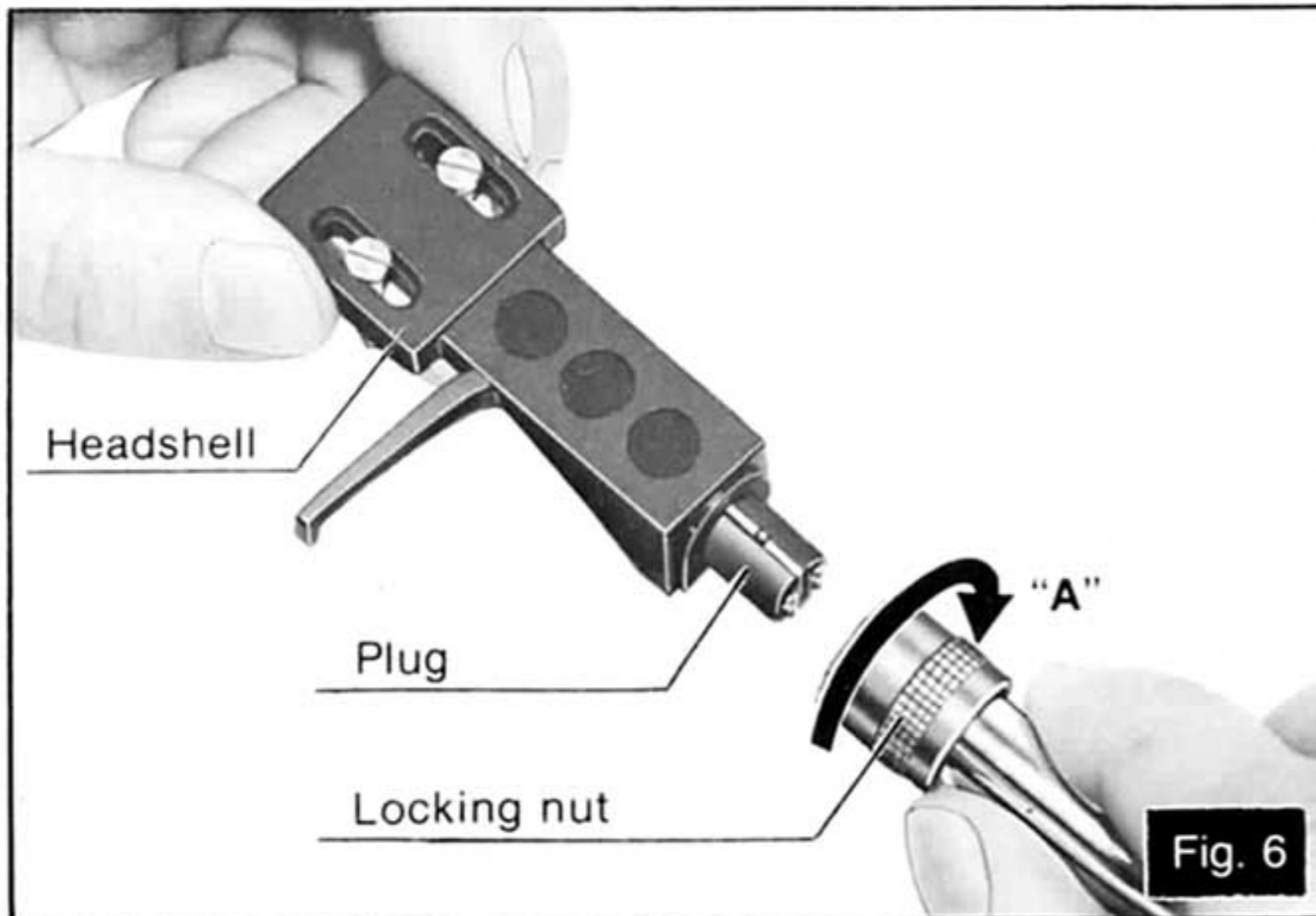

### ④ Installation of the balance weight (See Fig. 7.)

Release the arm clamp and remove the tonearm from the arm rest to provide enough space for inserting the balance weight.

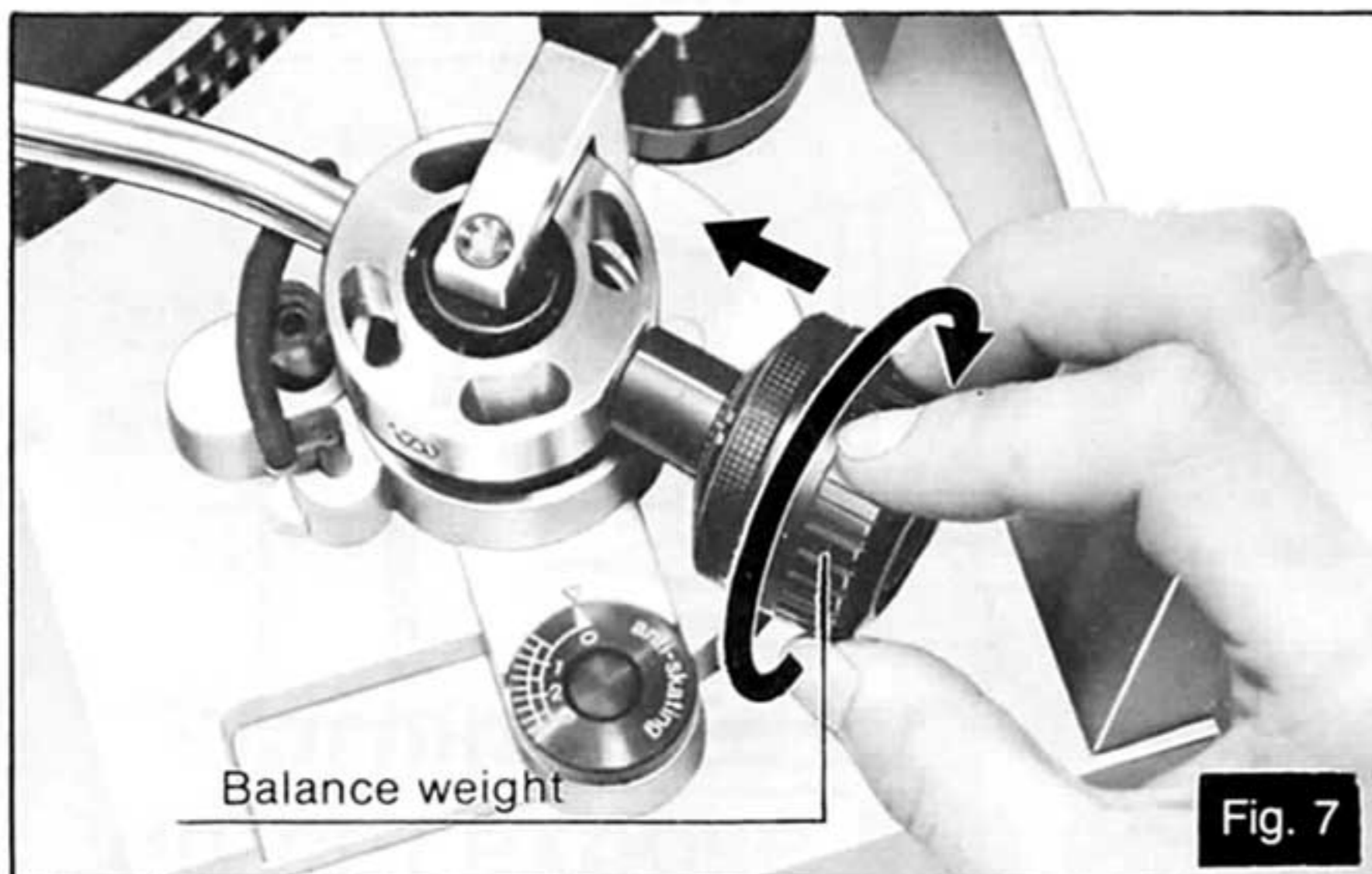

### ⑤ Adjustments of horizontal zero ("0") balance and stylus pressure

1. Remove the stylus protector, if your cartridge has a detachable one. Be careful not to touch your fingers to the stylus tip.
2. Release the arm clamp and lift the tonearm from the arm rest to free it.

#### Note:

- When you move the tonearm toward the center spindle, the turntable platter will move slightly, even if the speed select knob is at the "•" position, but this movement is not significant.
  - If the tonearm pulls toward the arm rest when the tonearm is held in a free state as shown in the picture (See Fig. 8), rotate the turntable platter clockwise about 10 times. This will disengage the automatic mechanism from the tonearm gear, which in rare cases may have moved out of its normal position during transportation.
3. Turn the entire balance weight clockwise (indicated by the arrow "A") or counterclockwise (indicated by the arrow "B") until the tonearm is approximately balanced horizontally (floats freely). (See Figs. 8 and 9.)

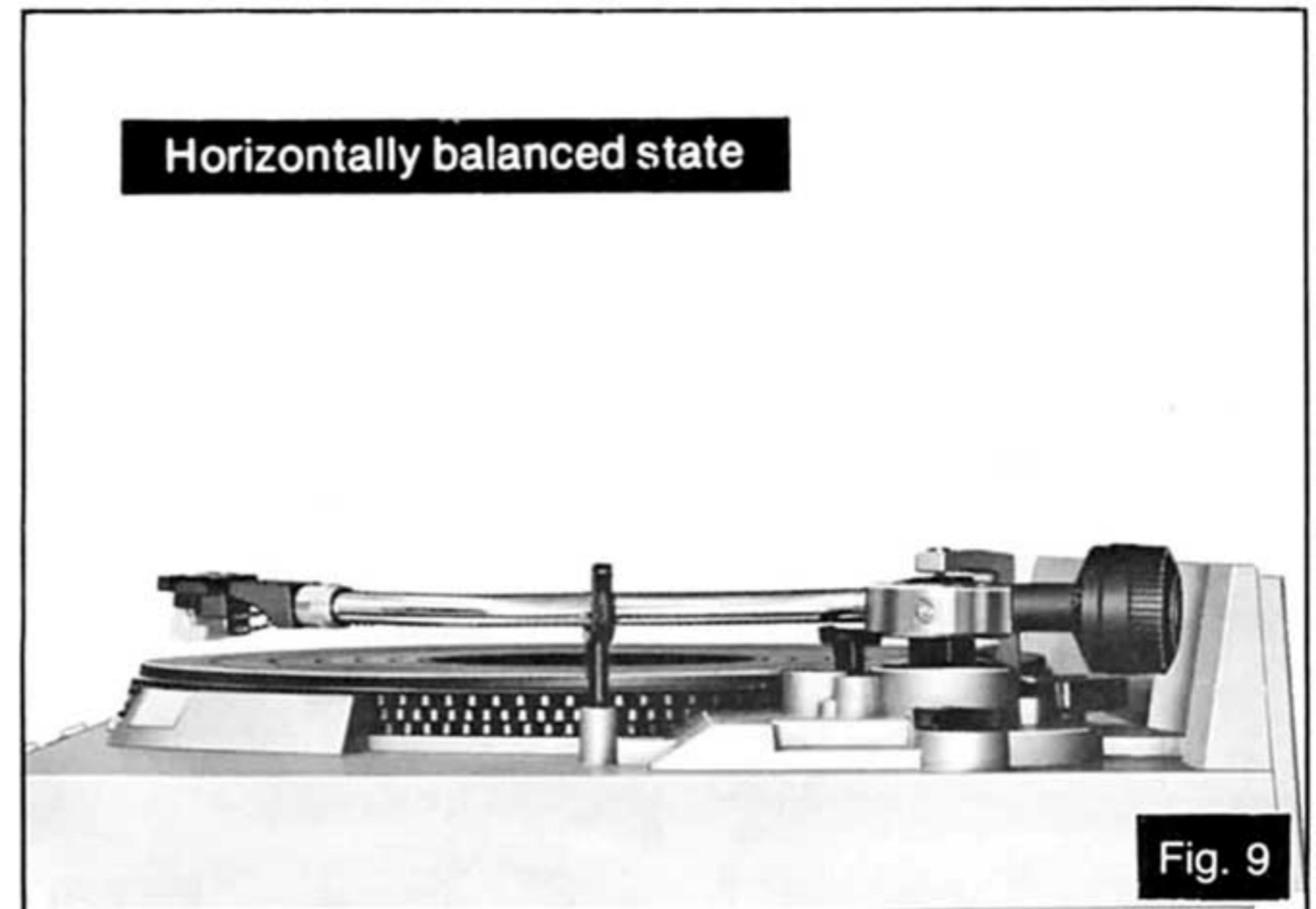

#### Note:

- During the adjustment of the horizontal "0" balance, be careful that the stylus tip of the cartridge does not contact the turntable mat or turntable base.
4. After the tonearm is horizontally "0" balanced, temporarily refasten the tonearm with the arm clamp.

5. Hold the balance weight stationary with one hand, as shown in the picture, and rotate only the stylus-pressure ring to bring the numeral "0" of the ring into alignment with the center line of the tonearm rear shaft. The adjustment of the horizontal "0" balance is now completed. (See Fig. 10.)

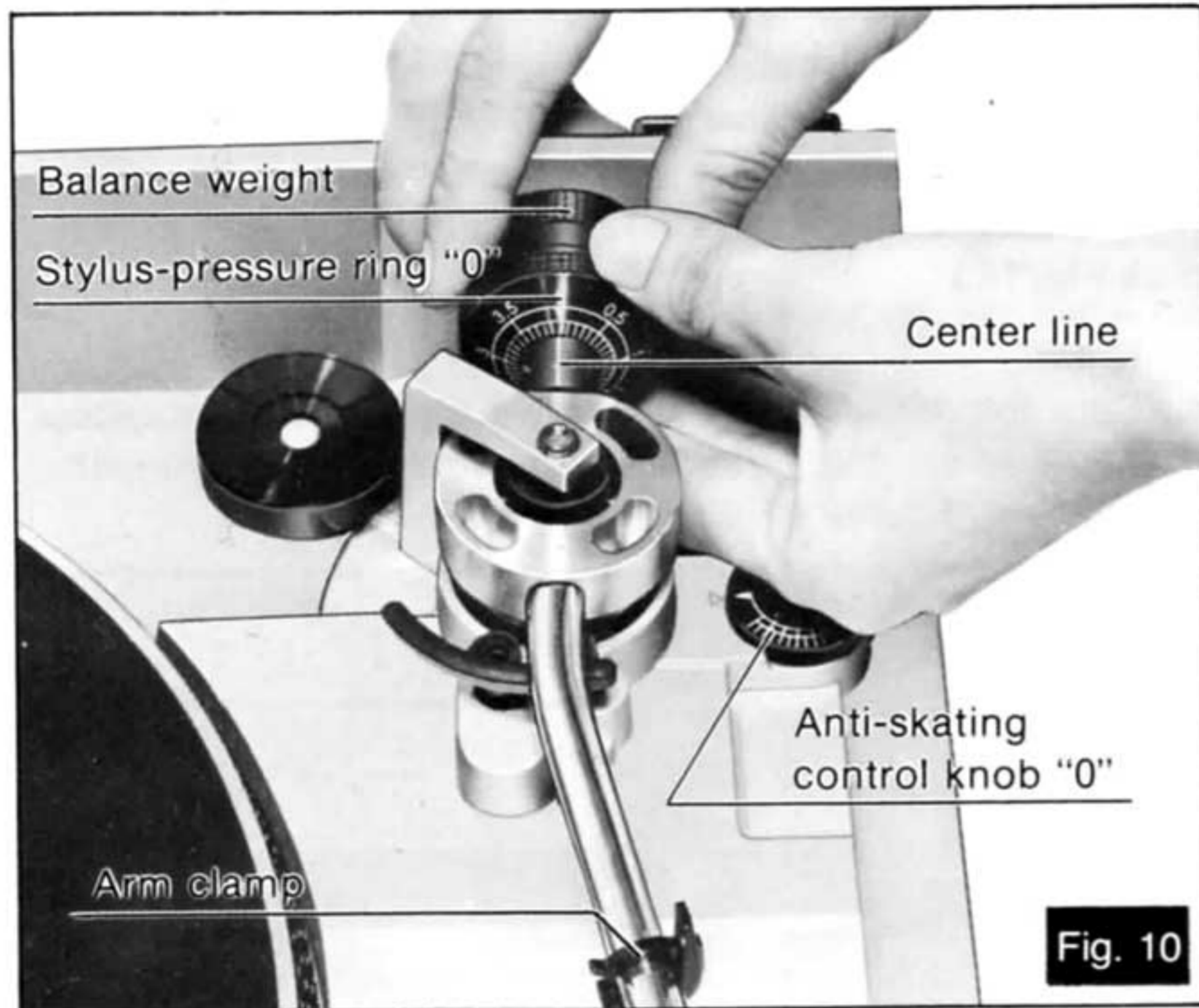

Fig. 10

6. After adjusting the horizontal "0" balance, turn the balance weight clockwise in the direction of the arrow and align to the correct stylus pressure. (Follow the cartridge manufacturer's recommendation.) (See Fig. 11.)

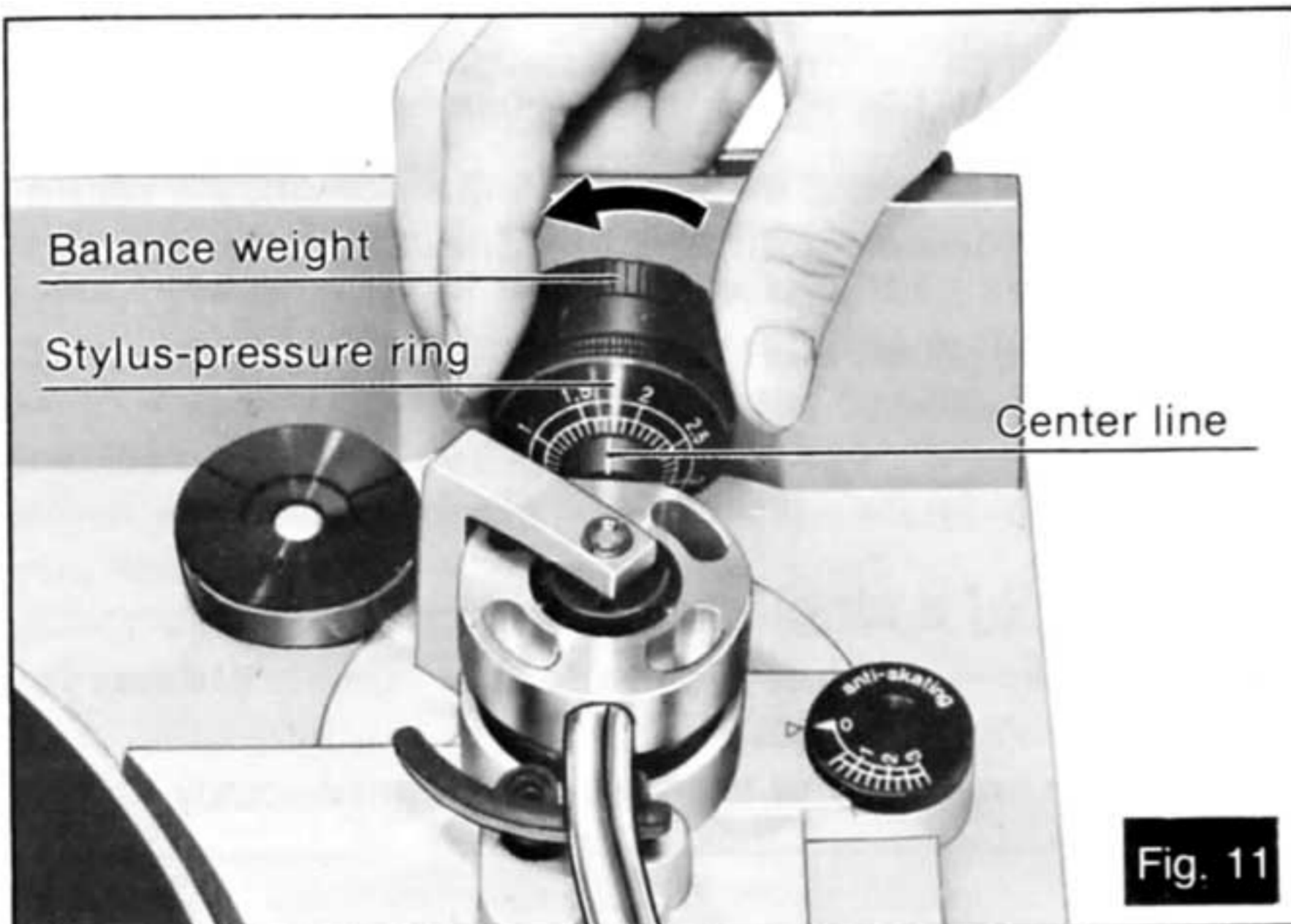

Fig. 11

**Note:**

- As the stylus-pressure ring moves in step with the balance weight, proper stylus pressure can be selected by directly reading the graduated ring.
- Set the stylus pressure to the maximum recommended value for your cartridge in cases where the record has an extremely high recording level, or where the unit is operated in a room at low temperature, or in places in which the unit is subjected to vibrations.

**⑥ Adjustment of the anti-skating control**

Set the anti-skating control knob to the same value as the stylus pressure. (See Fig. 12.)

**Note:**

- When a cartridge with integral dust brush is used, follow the cartridge manufacturer's recommendation for adjusting both stylus pressure and anti-skating force.

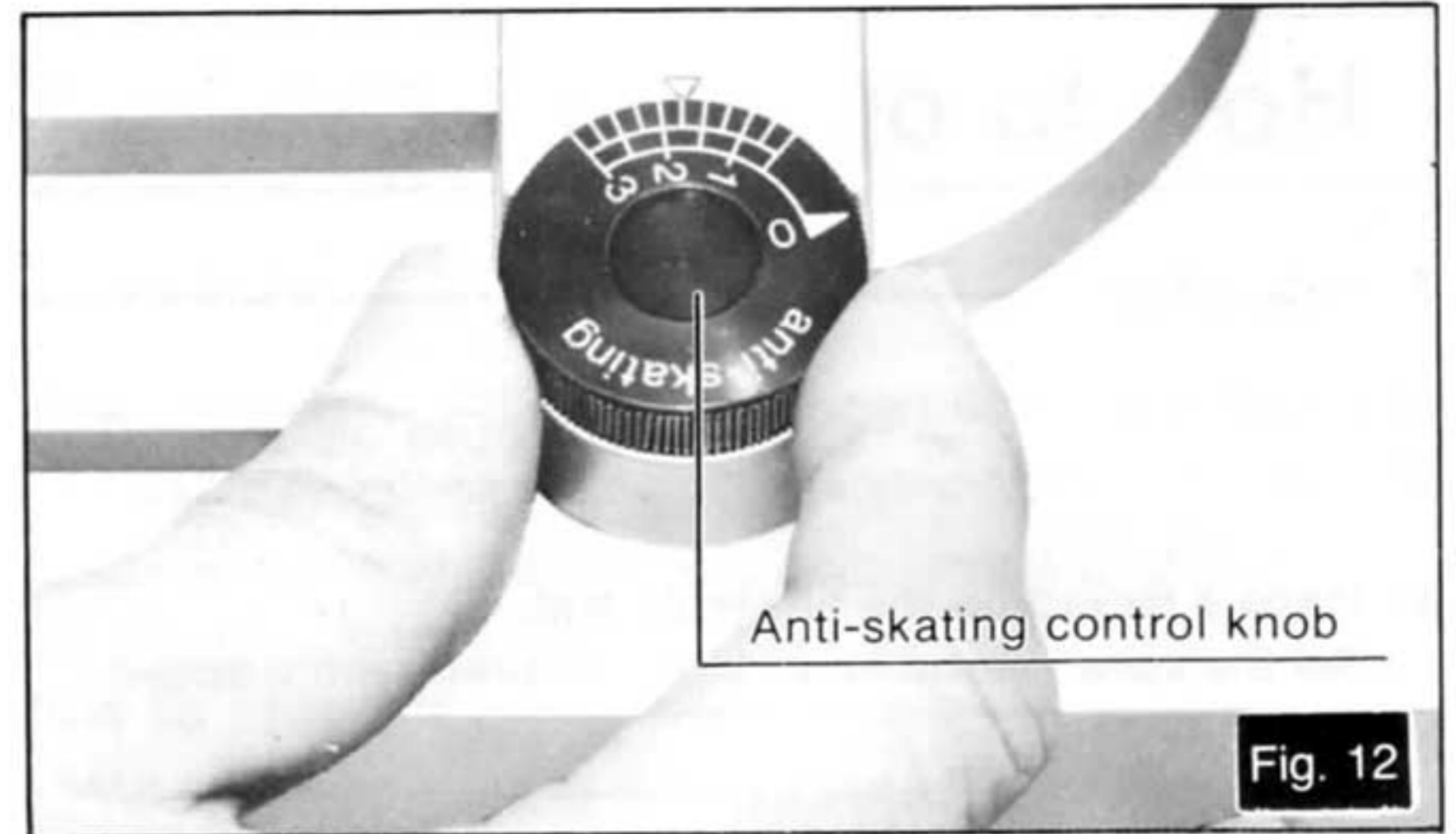

Fig. 12

**⑦ Installation of the dust cover**

Place the dust cover into position from directly above, holding it at both sides. For detaching the dust cover, be certain first to raise it as illustrated before removal. (See Fig. 13.)

**Note:**

- Opening or closing of the dust cover during play should be avoided. This may not only cause undesired vibrations, but also result in skipping of the stylus.
- If you must open the dust cover during play, do so as gently as possible.



Fig. 13

**⑧ Placement**

1. Place the unit in a stable and horizontal position, where there is little or no vibration.
2. Locate the unit as far away from the speakers as possible and isolate the unit from sound radiation from them.
3. Do not place the unit where it is exposed to direct sun, dust, moisture or heat.
4. Keep it in a well ventilated place.

**⑨ Connections**

1. **Connect the AC power plug.**

Connect the AC power plug to an AC wall socket (120V, AC).

2. **Connect the output terminals.**

**Output terminals      Amplifier or Receiver**

L(White)      →      **L**      Channel

R (Red)      →      **R**      Channel

GND (Spade lug)      →      **GND**

**Note:**

- Be sure to connect the ground terminal firmly to the amplifier or receiver. If this connection is not made or is loose, a power source "HUM" will result.

## ■ Single-play

### Manual play of a record

- 1 Install the single-play spindle on the center spindle. (See Fig. 14.)
- 2 Place a record on the turntable mat.
- 3 Set the speed select knob to the desired record speed. (See Fig. 15.)

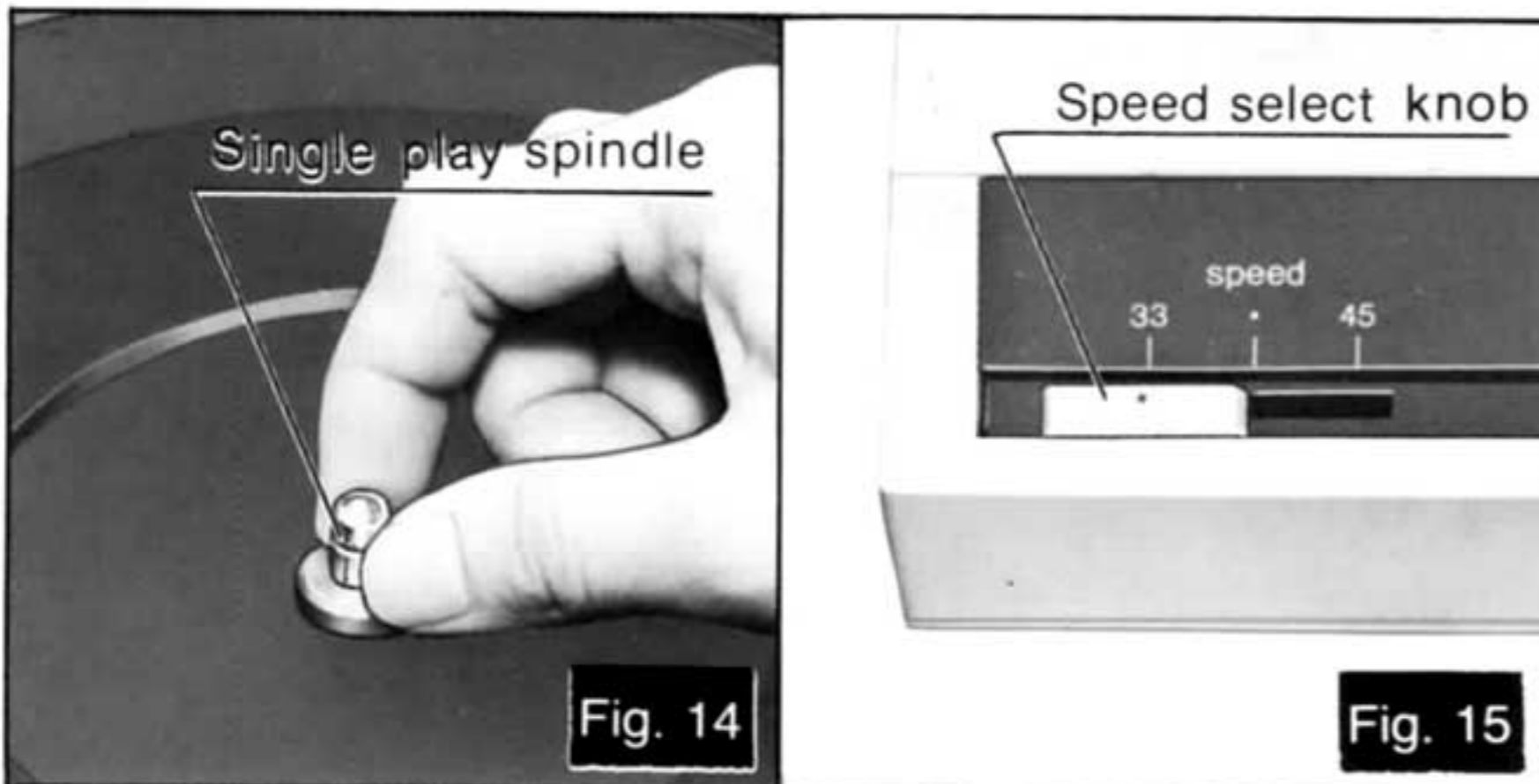

- 4 Remove the stylus protector, if your cartridge has a detachable one.
- 5 Release the arm clamp.
- 6 Set the cueing knob to the “▼” position. (See Fig. 16.)
- 7 Move the tonearm over the desired groove. When you move the tonearm toward the center spindle, the turntable platter will rotate.
- 8 Move the cueing knob to the “▲” position. (See Fig. 17.) The tonearm will descend slowly onto the record and play will begin.

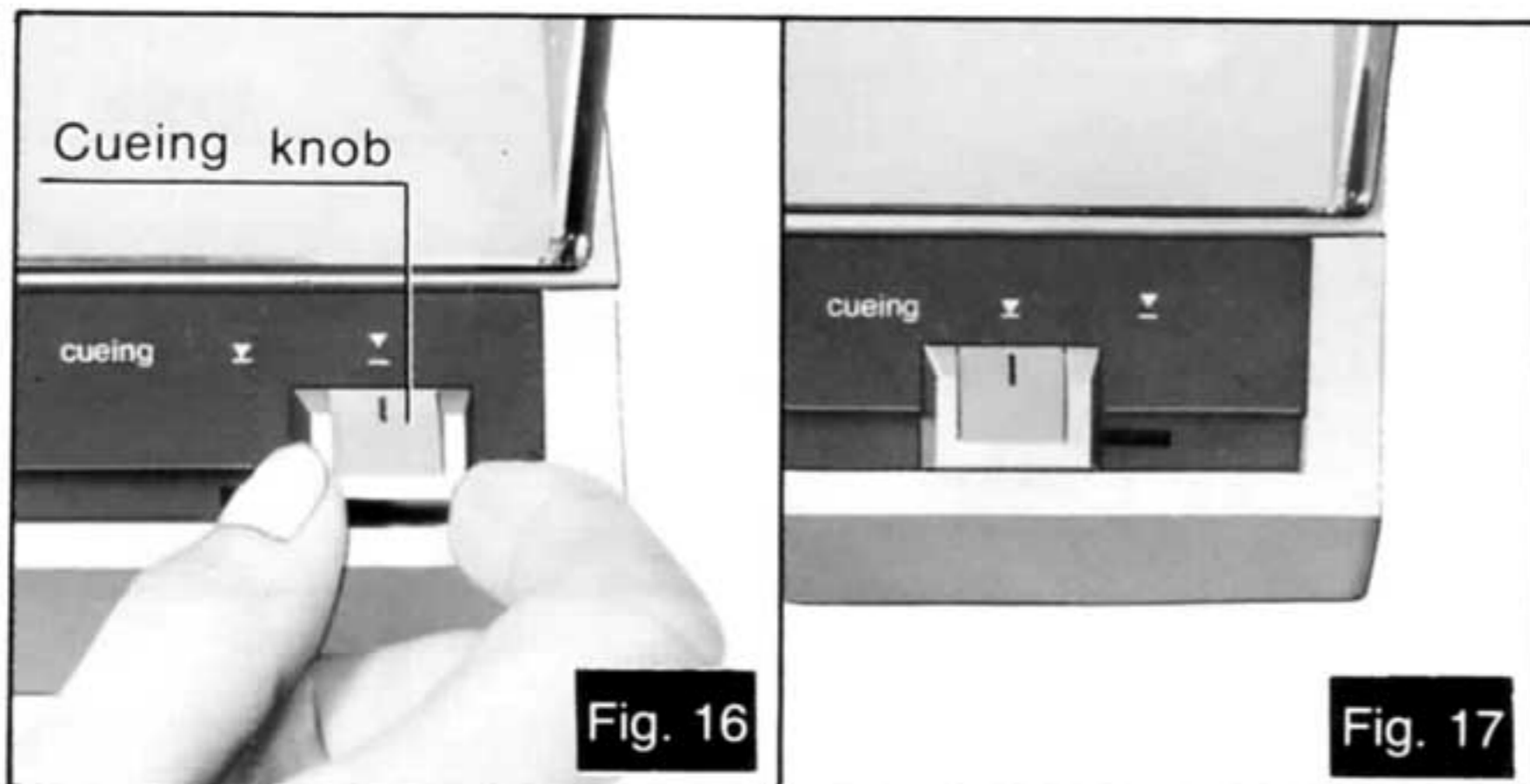

- 9 When play has finished, the tonearm will automatically return to the arm rest (auto-return) and the turntable platter will stop rotation. (The turntable platter will continue to rotate briefly due to its own inertia.)

#### Note:

- If the “memo-gram” knob is in a position other than “0”, play will be repeated by the number of times set; therefore, be sure to keep the “memo-gram” knob in the “0” position.
- After play is completed, fasten the tonearm with the arm clamp and set the speed select knob to the “•” position.
- Attach the stylus protector again, to protect the stylus tip from damage.

### Fully automatic single-play

- 1 Set the speed select knob in the same manner as in manual play and release the arm clamp.
- 2 Set the record size select knob to the diameter of the record (7" (17 cm), 10" (25 cm) or 12" (30 cm)) you wish to play. (See Fig. 18.)

#### Note:

- Care should be taken not to move the record size select knob when the tonearm is moving in the automatic start or automatic return cycle.

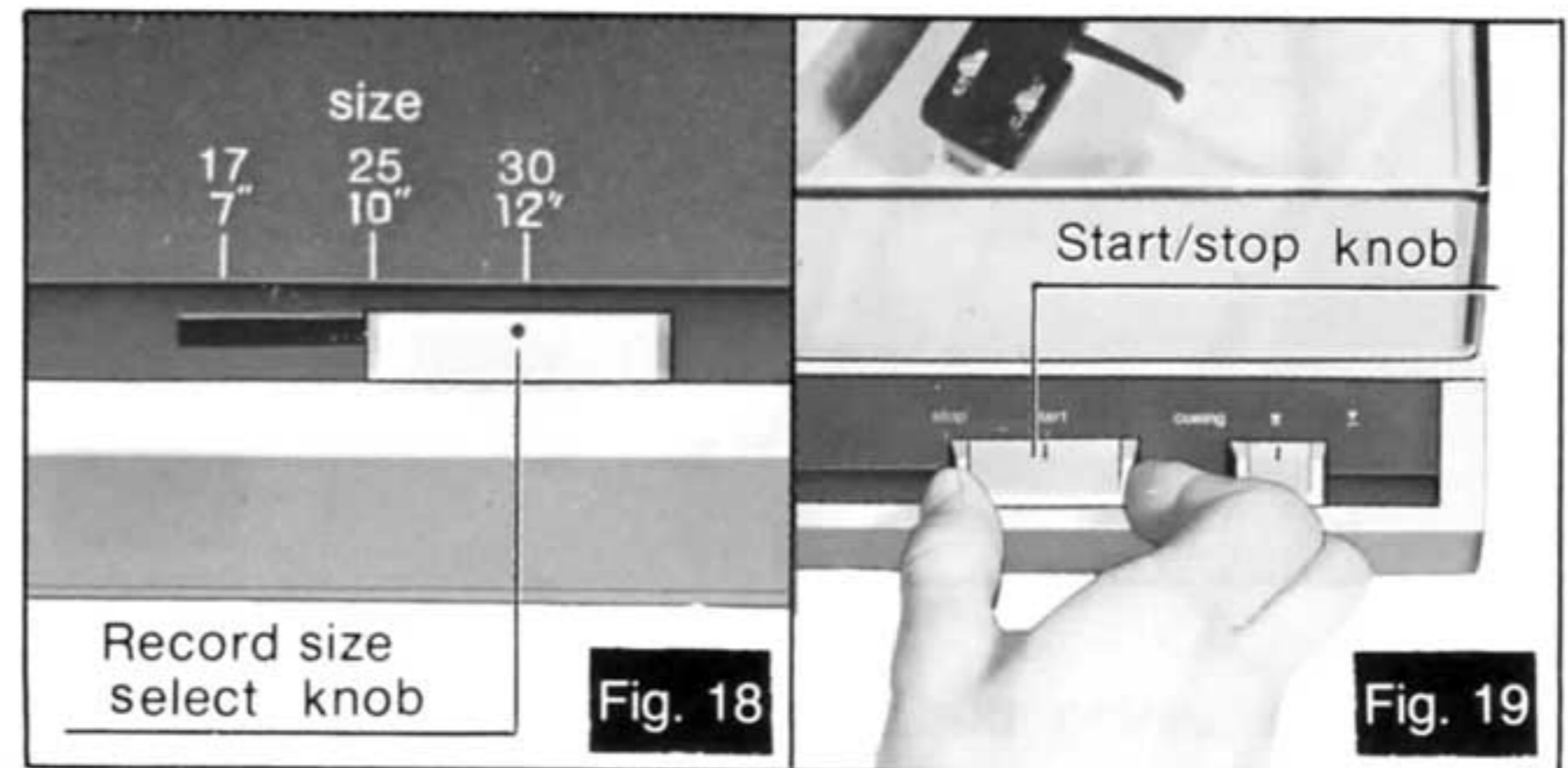

- 3 Move the start/stop knob to the “start” position. (See Fig. 19.) The tonearm will move automatically over the lead-in groove and descend slowly to the record (auto-start). Play will begin.
  - Note:
    - In this case, the “start/stop” knob will automatically return to the neutral position after play has begun.
- 4 When play has finished, the tonearm will automatically return to the arm rest (auto-return) and the turntable platter will stop rotation. (The turntable platter will continue to rotate briefly due to its own inertia.)

### Repeat play of a single record

- 1 Set the “memo-gram” knob to the desired number of times you wish to play. (See Fig. 20.) “R” position enables you to repeat play continuously.

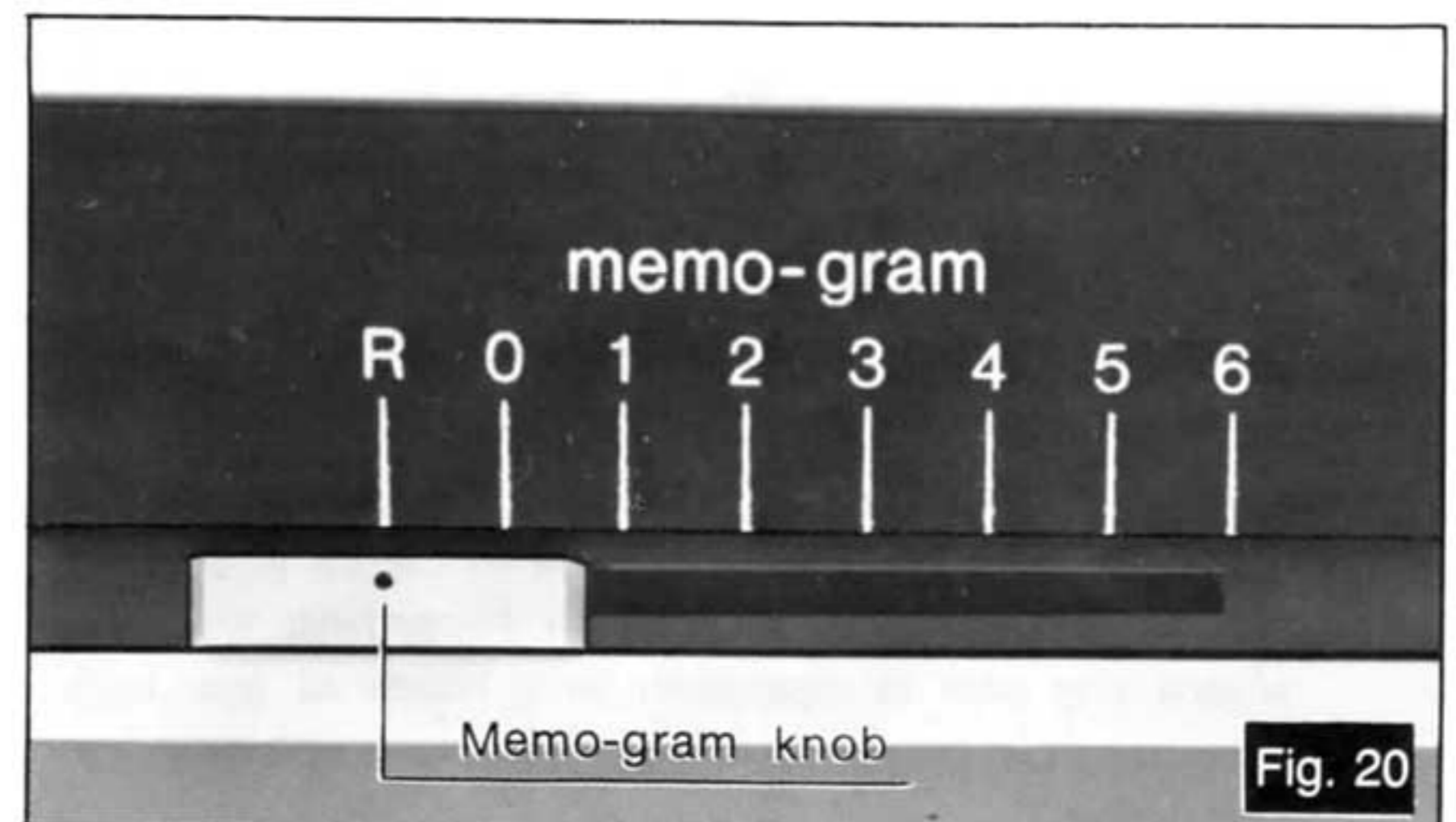

#### Note:

- The “memo-gram” knob may be set to a desired number, *except* during automatic start or automatic return cycle.
  - If you start play manually while the “memo-gram” knob is set to a number, there will be an additional repeat play.
- 2 Start play in the same way as for fully automatic single-play.

## ■ Multiple-disc operation

- 1 Insert the multiple-play spindle, aligning the key at its base with the slot of the center spindle. (See Figs. 21 and 22.) Then, pushing downward, rotate the spindle clockwise until it stops.

To remove the spindle, push it down, turn counterclockwise until it feels loose and lifts upwards.

Before removing the multiple-play spindle, always make certain that records are removed first.

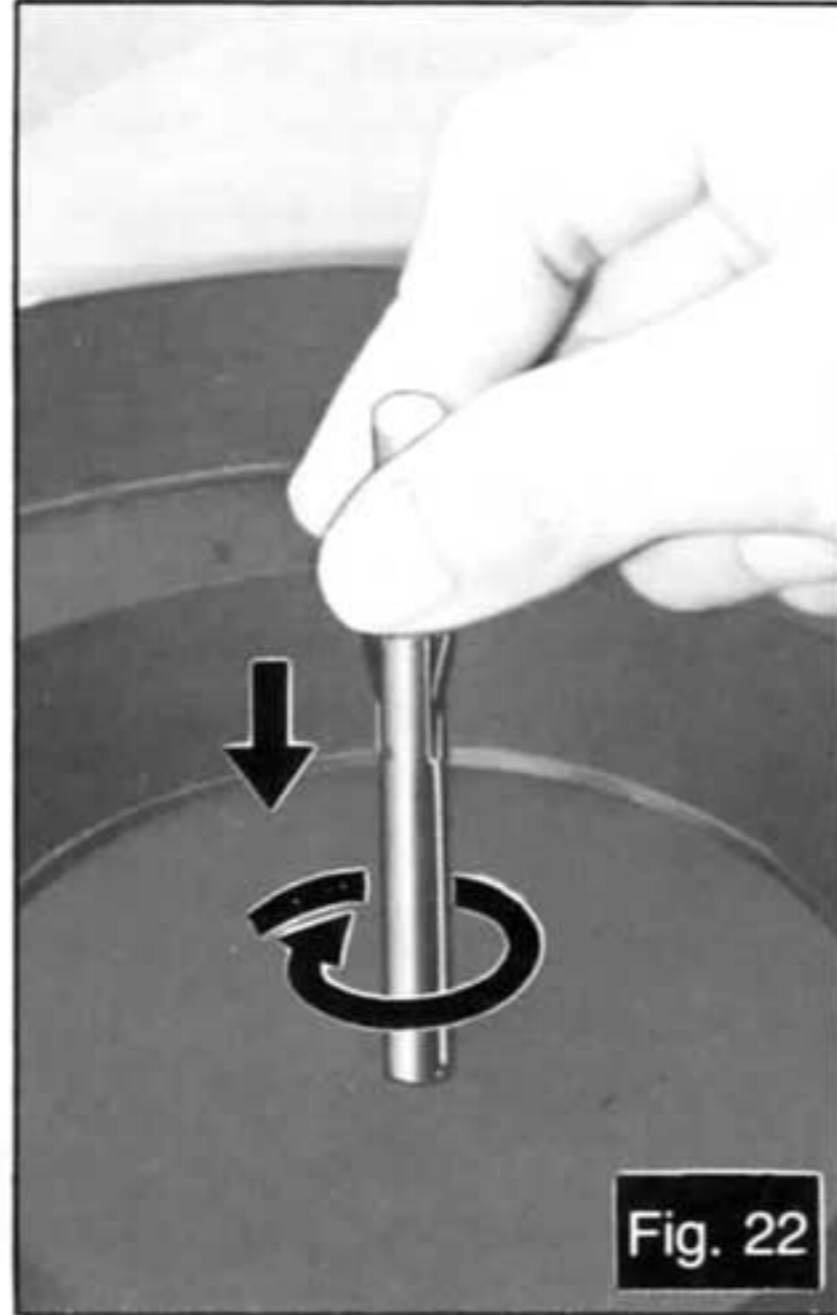
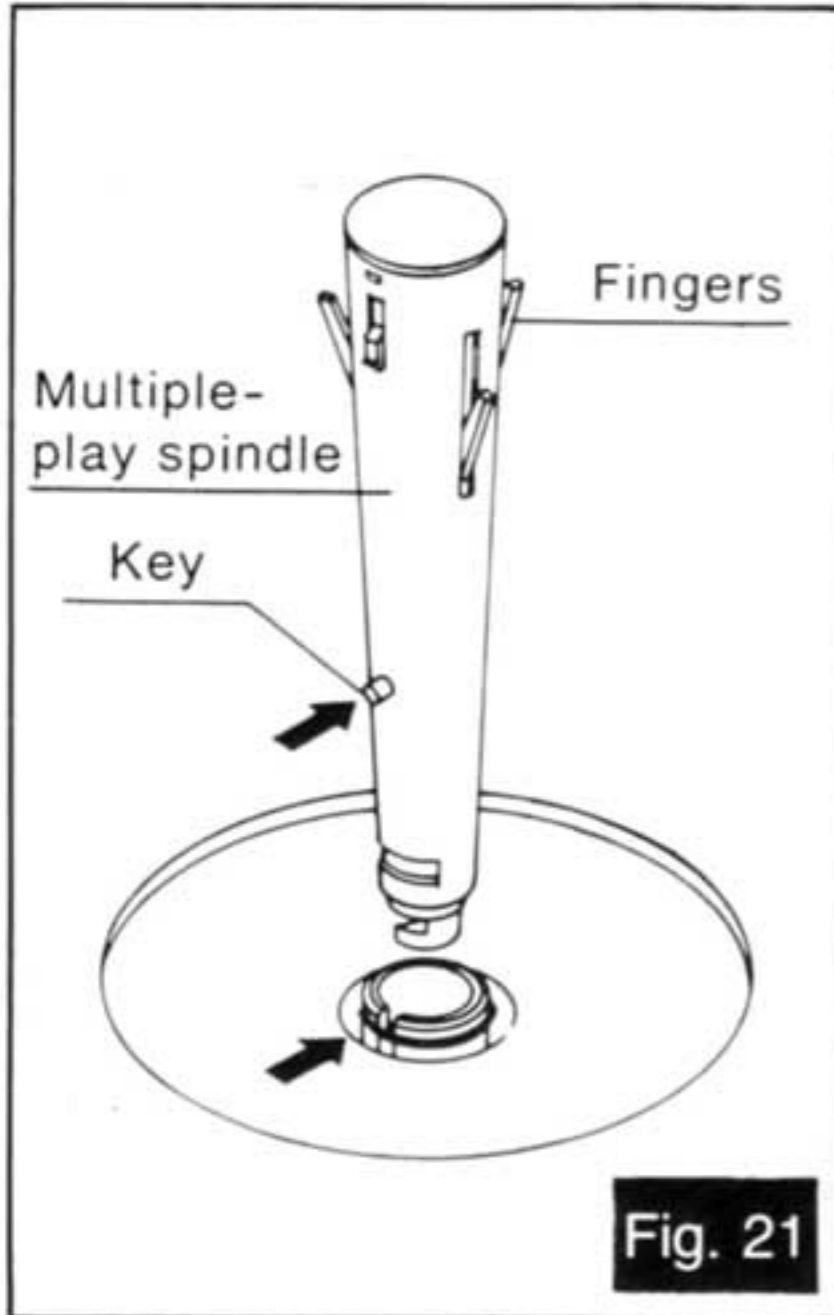

### Note:

Never insert or remove the multiple-play spindle when the automatic mechanism is in operation or engaged.

- 2 Stack records of the same size on the fingers of the multiple-play spindle. Never mix different record diameters.
- 3 Count the number of records stacked, then set the "memo-gram" knob to the number corresponding to the records; i.e., when you stack three records, set the "memo-gram" knob to the "3" position. (See Figs. 23 and 24.)

When you stack a single record on the multiple-play spindle, you need not set the "memo-gram" knob.

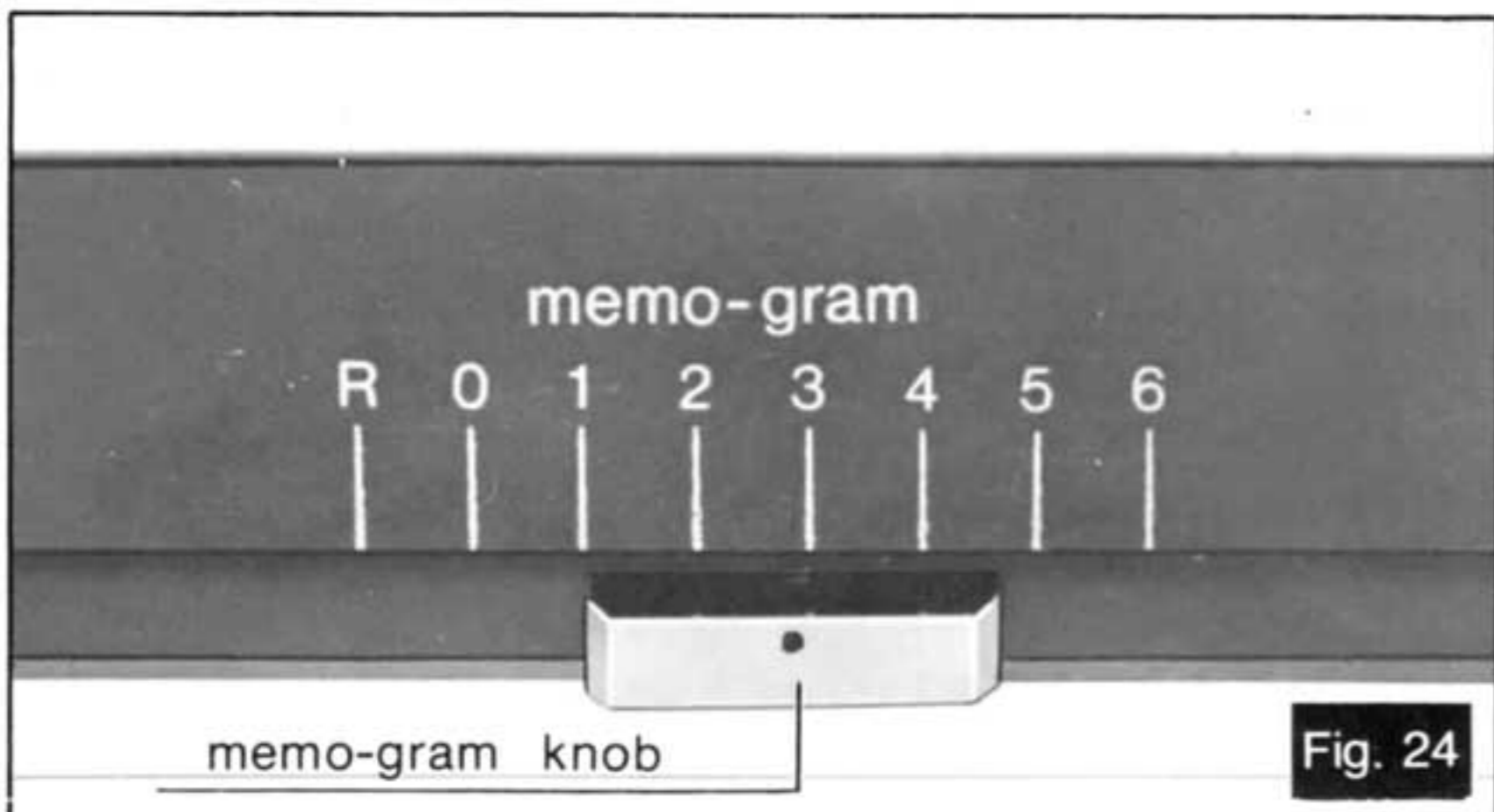

## ■ Multiple-disc plus repeat play

Set the "memo-gram" knob to the "R" position for multiple-disc, and you can play the last record repeatedly (repeat).

## ■ How to stop play

Set the start/stop knob to the "stop" position. (See Fig. 25.)

The tonearm automatically returns to the arm rest, and the turntable stops rotating.

Of course, the unit will automatically shut off even when the tonearm is manually returned to its arm rest directly.

### Note:

Before you operate the start/stop knob, make sure that the "memo-gram" knob is set at the "0" position.

If this knob is set at any position other than "0", the repeat play is continued by the number of times indicated, even if you set the start/stop knob to the "stop" position.

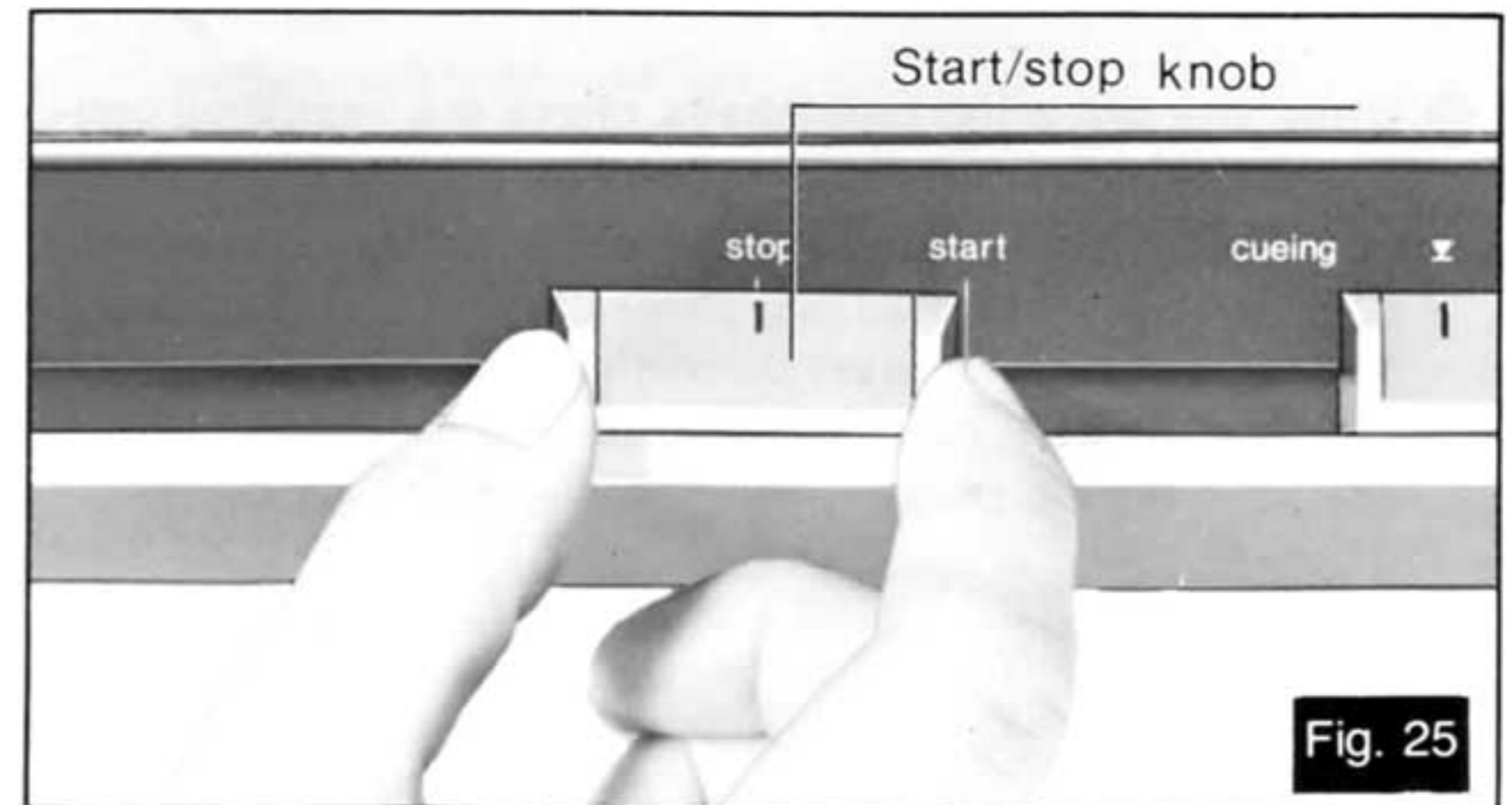

## ■ How to suspend play

Set the cueing knob to the "▼" position.

The stylus tip of the cartridge will be lifted from the record.

## ■ If the unit is not to be used for some time

- Secure the tonearm with the arm clamp.
- Attach the stylus protector, if your cartridge has one, to guard the stylus from damage.
- Close the dust cover.

## ■ When you play a 45-rpm record with a large center hole

- In the case of "single-play", place the 45-rpm adaptor for single-play on the regular single-play spindle.
- In the case of "multiple-play", insert the 45-rpm multiple-play adaptor into the center spindle, in the same manner as the regular multiple-play spindle.

## Note and Maintenance

- ❶ **Never move the "start/stop" knob, "record size select" knob and "memo-gram" knob during automatic cycle (auto-start and auto-stop).**
  
- ❷ **Records having sizes other than 17 cm, 25 cm and 30 cm (7", 10" and 12") should be played manually.**  
Your turntable is designed for automatic handling of records that adhere to accepted industry dimensions. Therefore, use the unit manually for records other than standard sizes.  
**Note:**  
Warped records or those especially thinner or thicker than standard should also be played manually only. If such records are used for multiple-play operation, two records may drop simultaneously, or the record may not drop at all.
  
- ❸ **Use the cueing knob only for single-play operation (one record only).**
  
- ❹ **When you use other headshells, check the headshell configuration for compatibility. (See Fig. 26.)**  
When other types of headshells are employed, the handle portion of the headshell may strike against the inner, upper surface of the dust cover during automatic motion of the tonearm. In such case, we recommend the dust cover be left open during play.

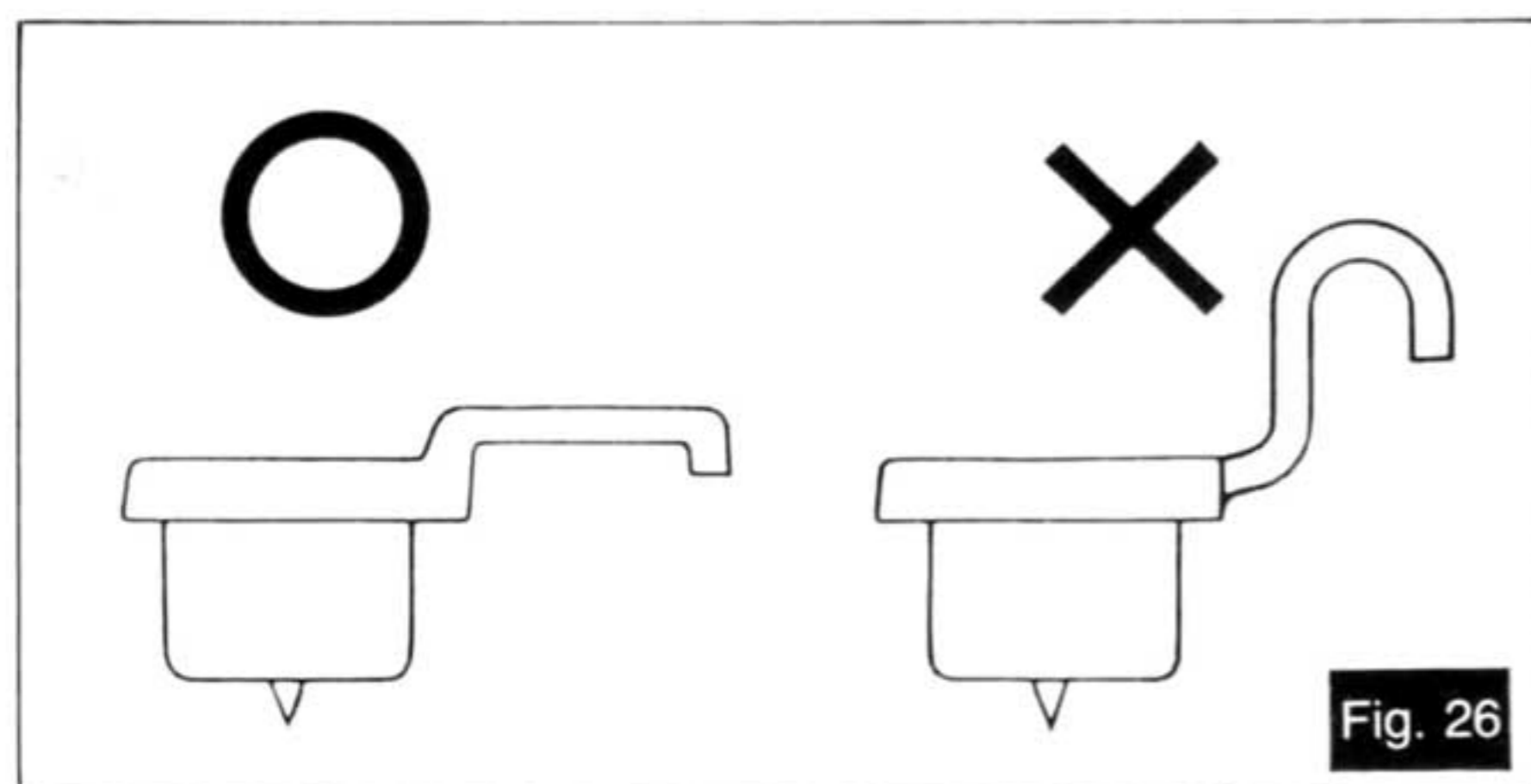

- ❺ **Before detaching or attaching the headshell, be sure to turn the power of the amplifier or receiver off.**  
Noise produced by detaching or attaching of the headshell, with the volume control turned up, may cause damage to the speakers.
  
- ❻ **When play is finished, be sure to secure the tonearm with the arm clamp.**  
After play is finished, if the unit is not to be used for some time, care should be taken to secure the tonearm to protect the stylus tip.  
For the same reason, the stylus protector should also be attached.

- ❼ **Wipe the headshell terminals from time to time.**  
Dust and dirt at the headshell terminals may result in increased "HUM" noise or intermittent sound. Use a soft dry cloth to clean the headshell terminals.
  
- ❽ **Wipe the dust cover and turntable base with a soft, dry cloth.**
  - Never use any cleaners containing alcohol, benzine or thinner.
  - Use of a chemically treated dust cloth should also be avoided. Be sure that the dust cover is not exposed to insecticide spray.
  - To remove stubborn finger prints or grease spots, detach the dust cover and disconnect the AC power plug.  
Use a soft cloth slightly moistened with a mild soap and water solution.
  - Do not wipe the dust cover during play, or the tonearm may be attracted toward the dust cover due to the generation of static electricity.
  
- ❾ **Dust and dirt should be carefully removed from stylus tip or records.**  
Dust and dirt on stylus tip or record may not only result in deterioration of tone quality, but cause undue wear of the record and the stylus tip itself.  
Special stylus tip brushes and record cleaners can be purchased in most electronic supply houses.

- ❿ **Replacement of the stylus (for SL-235A). (See Fig. 27.)**  
**Note:**
  - The stylus will give you many hours of listening pleasure.
  - To prevent damage to your records it should be replaced at the first sign of wear.
  - Noise or scratchiness may indicate a worn or damaged stylus.
    - 1 Remove the headshell from the tubular arm by loosening the locking nut.
    - 2 Carefully grasp the stylus assembly and raise its top portion as shown in the illustration "A", then pull it as "B".
    - 3 Be careful not to touch the stylus tip, and install the new one in the reverse order like "B" to "A"



# Adjustments

## ① Adjustment of arm-lift height (See Figs. 29 and 30.)

- The arm-lift height distance between the stylus tip and record surface when cueing knob is at “▼” has been adjusted at the factory before shipping to approximately 15 mm.
- For using different cartridges available on the market or when further adjustments are particularly necessary, make adjustment as follows:
  1. Put on the stylus protector to protect the stylus tip from damage.
  2. Set the speed select knob to the “•” position to prevent the turntable platter from rotation.
  3. Move the tonearm towards the center spindle.
  4. Turn the adjustment screw clockwise or counterclockwise, while pushing the arm lift down. (See Fig. 30.)

### Clockwise rotation

—distance between the record and stylus tip is reduced.

### Counterclockwise rotation

—distance between the record and stylus tip is increased.

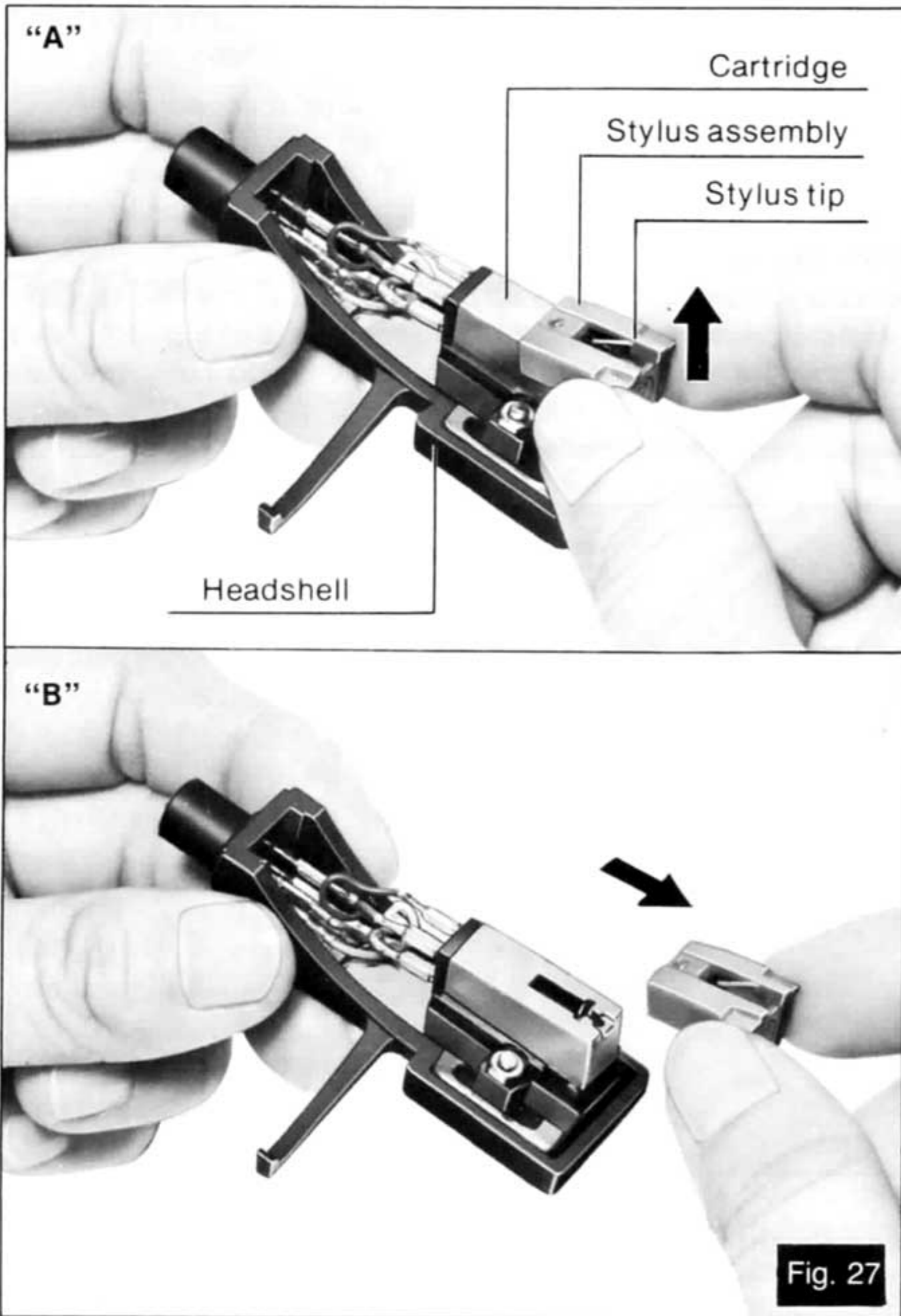

Fig. 27

Replacement stylus is the EPS-74STSD. You can also use the ATN71 replacement stylus which is sold by audio-technica U.S., Inc.

## ① How to remove and install the turntable platter (See Fig. 28.)

The belt is connected to the capstan and the inner drive rim of the turntable platter.

Before removing the turntable platter, release the belt from the capstan.

When reinstalling the turntable platter, lower it over the turntable shaft and then put the belt onto the capstan.

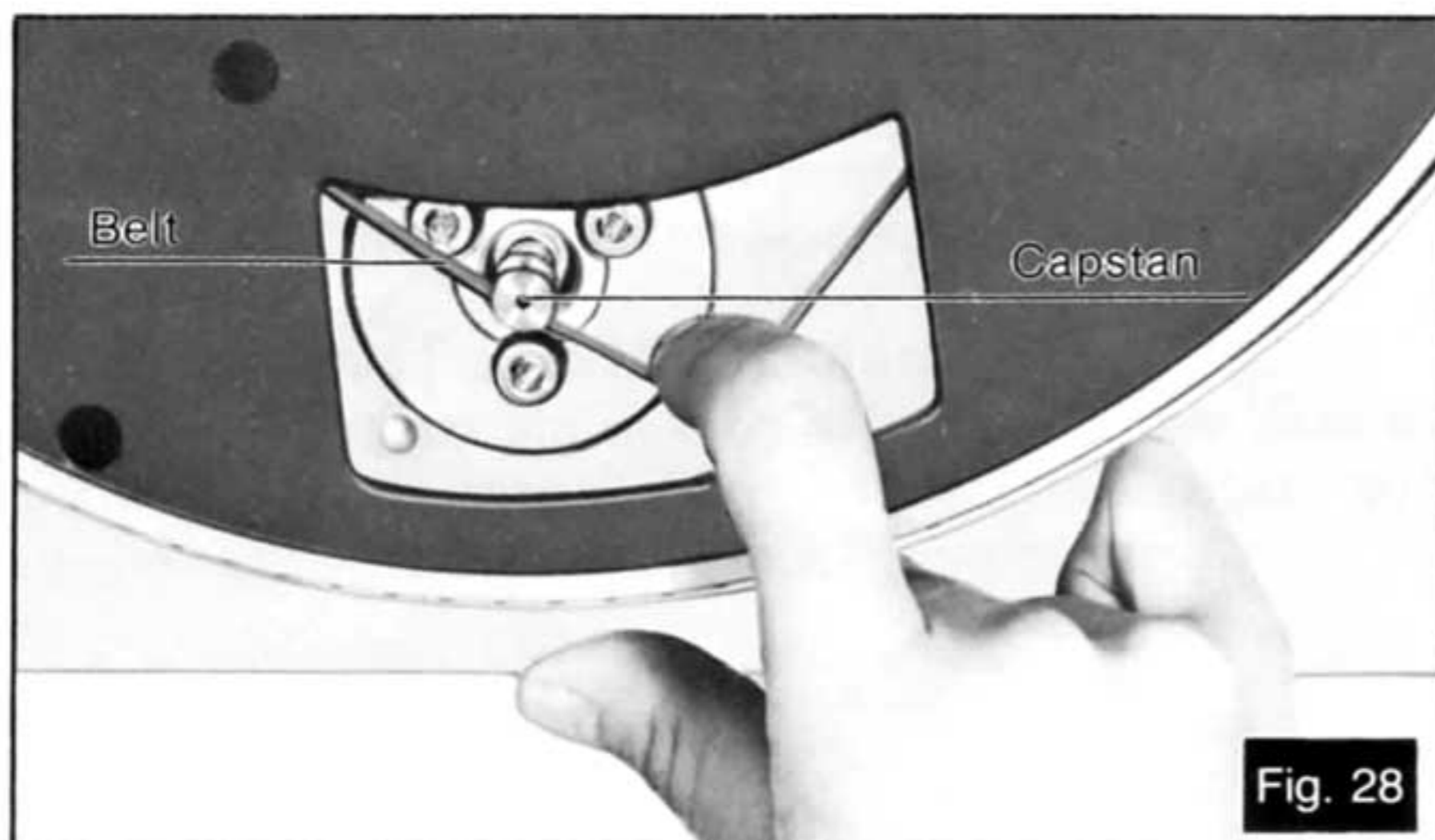

Fig. 28

### Note:

- Be careful not to let oil or grease contact the belt. If grease inadvertently contacts the belt, disconnect the AC power cord first and wipe the belt clean with alcohol.

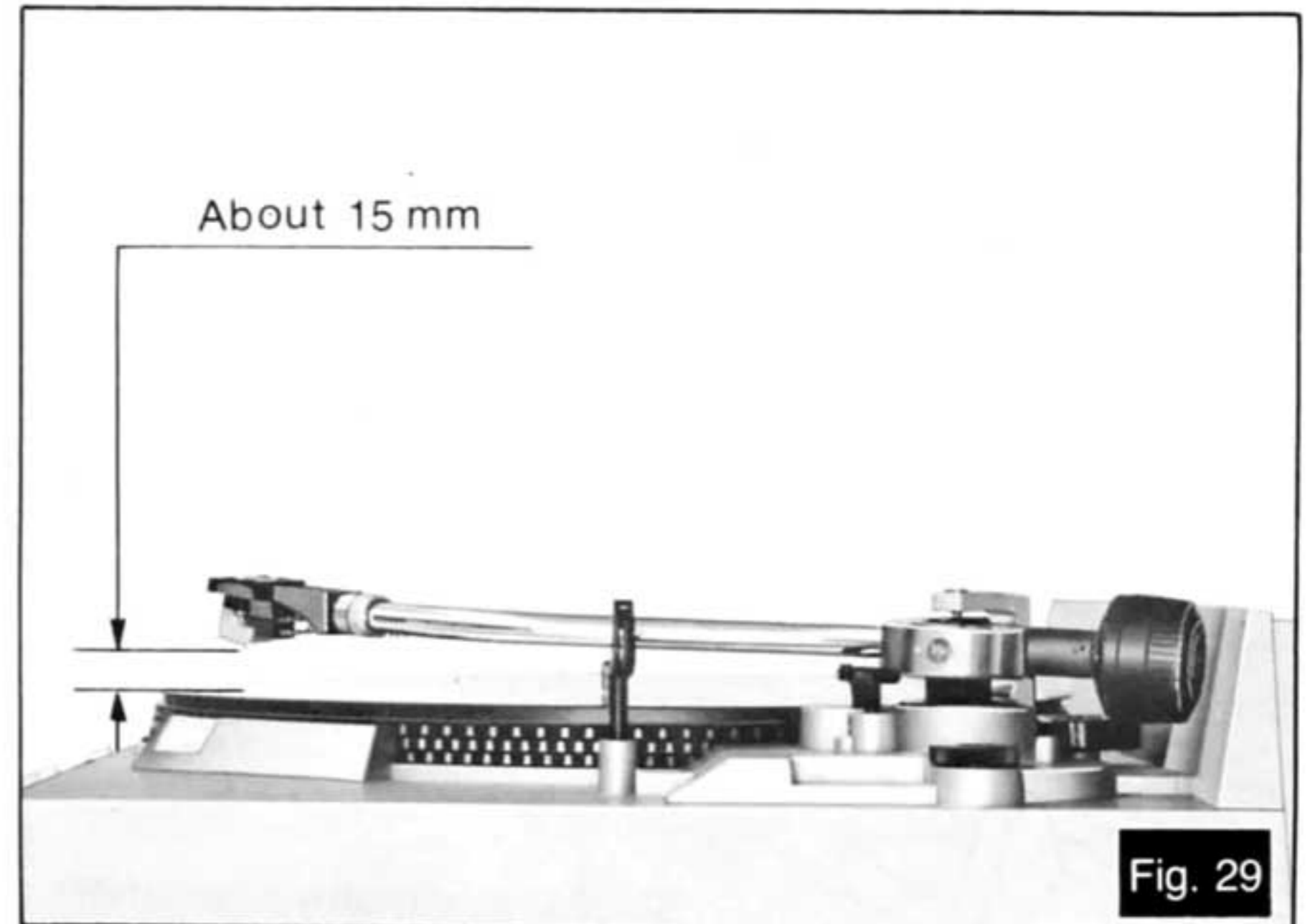

Fig. 29

### Note:

- As the adjusting screw has a hexagonal head, be sure to make the adjustment while depressing the arm lift, or the screw will not move freely. Also be sure that the hexagonal head retracts correctly into the arm lift when the latter is released.

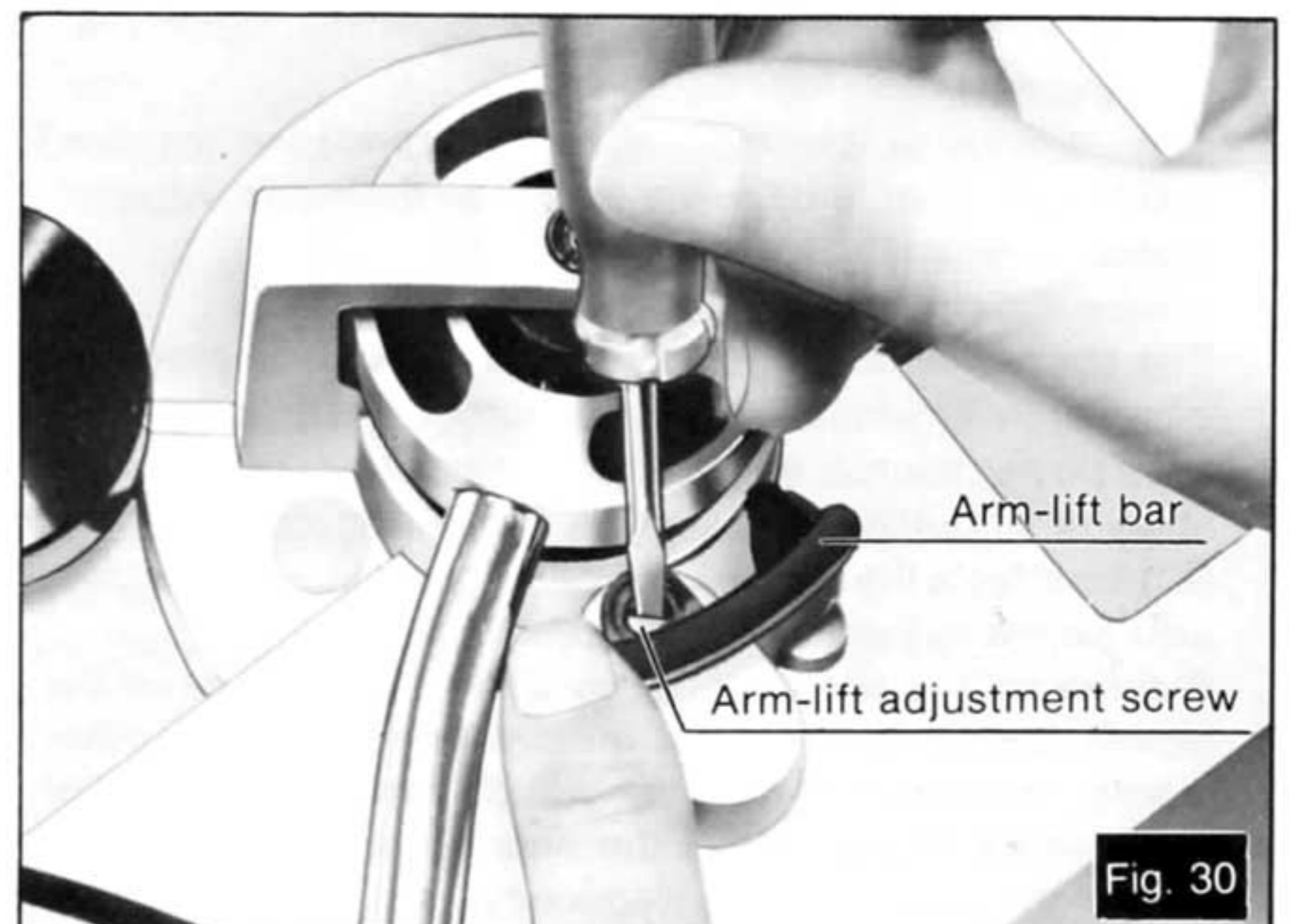
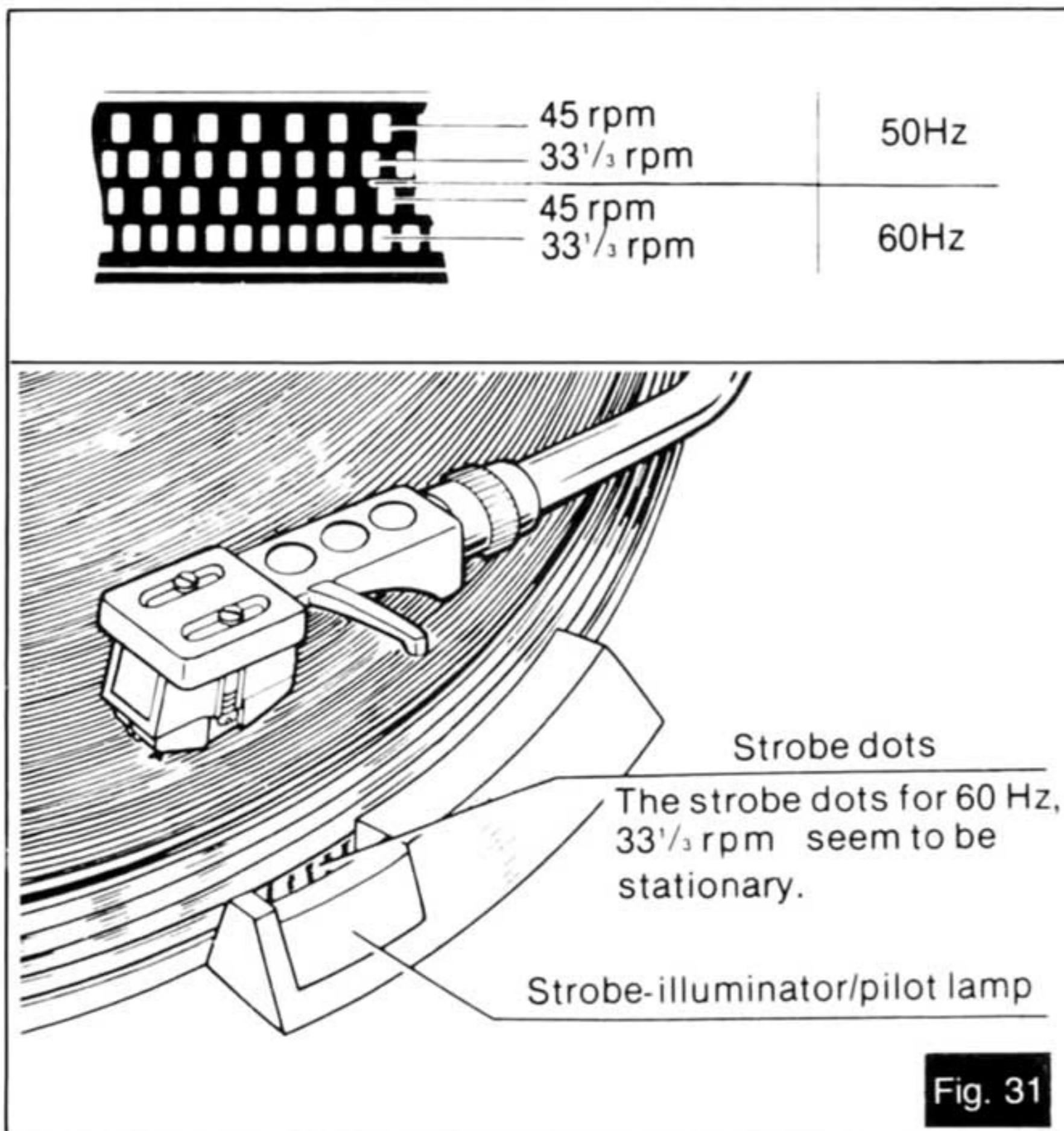

Fig. 30

**② Speed adjustment (With pitch control knobs)  
(See Fig. 31.)**

Strobe dots are set on the rim of the turntable platter according to the power-line frequency and the number of revolutions of the records. Make adjustment, referring to strobe-dot indication. (See Fig. 31.)

1. Place a record on the turntable mat.
2. Set the speed select knob to the speed to be adjusted.
3. Adjust the speed while playing a record.  
The strobe-illuminator/pilot lamp will be lit for illuminating the strobe dots.
4. While turning the pitch control knobs either to "+" side or "-" side, adjust so that the strobe dots of the turntable platter look as if they were stationary. The state under which the strobe dots seem to be stationary represents the correct number of revolutions.



**"+" direction**

This increases the speed of the turntable rotation, and the strobe dot pattern seems to flow in the same direction as the rotational direction of the turntable platter.

**"-" direction**

This decreases the speed of the turntable rotation, resulting in a state opposite to that in the "+" direction.

**Note:**

**Strobe dot pattern**

The strobe-illuminator/pilot lamp of this unit employs the commercially available power source. The frequency of such power source, when actually measured, has a fluctuation of about 0.2%. As such a fluctuation of the power source affects the strobe illuminator, the strobe dot pattern also seems to fluctuate to a certain extent.

But the unit is not affected by these fluctuations of the power source, since a DC motor is employed. In other words, rotation of the platter will be constant, and slight shifts in the movement of the dots simply reflect normal drift in the power-source frequency.

**③ Adjustment for automatic start and return positions  
(See Fig. 32.)**

Should the tonearm not function correctly, make adjustments according to the following procedures.

**Adjustment for automatic start position**

(Remove the rubber cap.)

In cases where the stylus tip descends outside of the record —**rotate clockwise.**

In cases where the stylus tip descends onto halfway of a recorded piece —**rotate counterclockwise.**

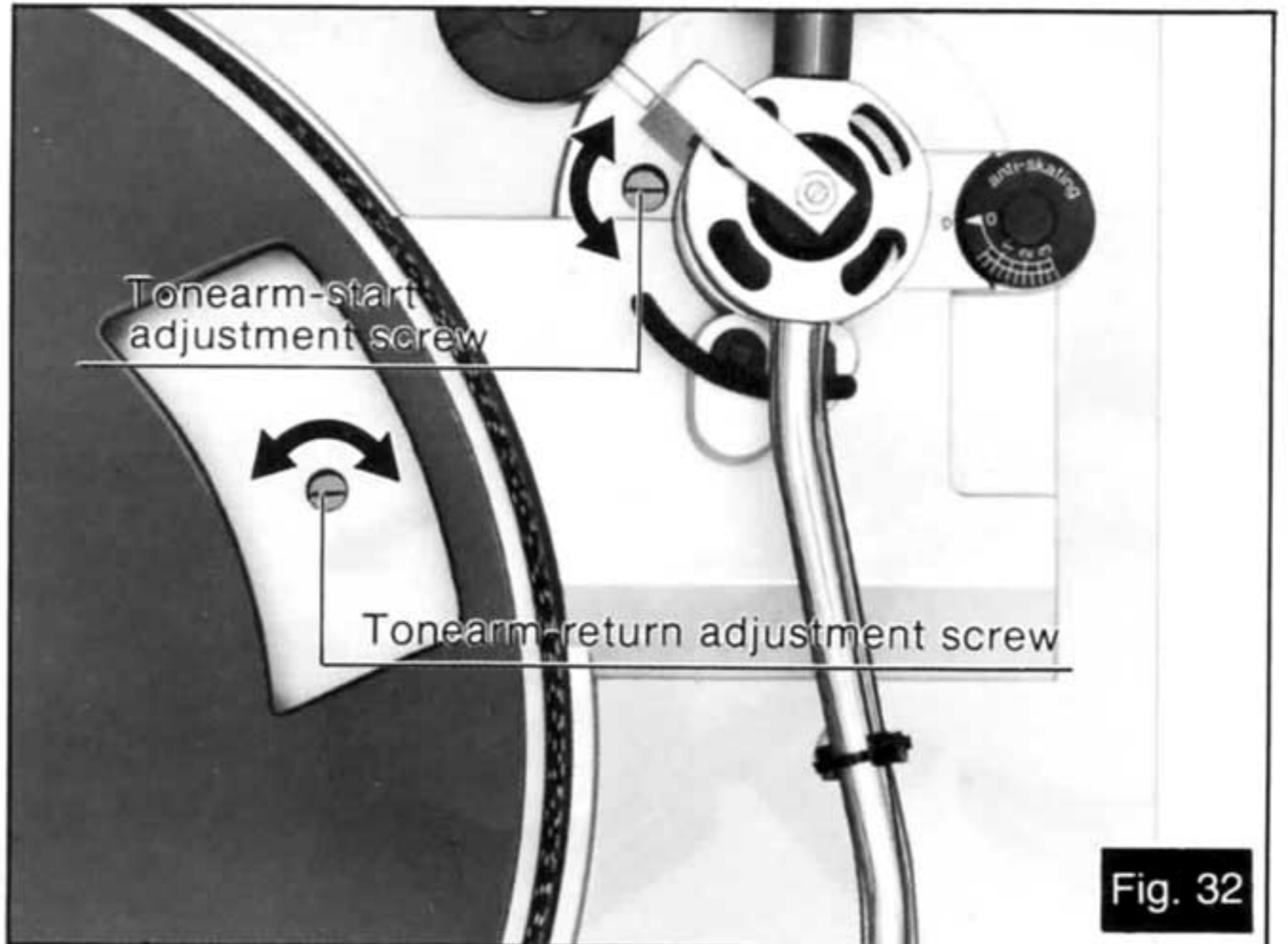

**Adjustment for automatic return position**

(Remove the turntable mat.)

In cases where the tonearm tends to return before the playing has finished —**rotate clockwise.**

In cases where the tonearm fails to return after the last groove of the record —**rotate counterclockwise.**

## Features

### ① New Type Frequency Generator Servo Control

One of the major secrets behind the razor-sharp accuracy and superb quality of sound lies in the new type (Frequency Generator) servo controlled DC motor, and greatly improved highly reliable IC circuitry. Even the slightest hint of speed change and drift is corrected immediately.

### ② Electronic Speed Switching

Even though this turntable is belt-driven, gone is the old conventional pulley type speed changing mechanism. Speed switching in this unit is fully electronic, thereby adding to the high degree of mechanical precision and reliability.

### ③ All Front-Panel Controls

The advancement to complete front-panel control marks a big step forward in turntable operation, not only because of the greater convenience, but also because of the greater protection from dust, as the dust cover can stay closed.

### ④ Tonearm Cueing Controlled from Front Panel

The tonearm is raised and lowered softly by a viscous-damped cueing lifter. Even with the dust cover closed, a cueing can be easily performed as the control is located on the front panel.

### ⑤ Fully-Automatic Operation

All operations in the SL-235 are completely automatic, yet mechanical movements are accurate and silent. Full protection to records and stylus tip is assured. This is due to the "memo-gram" function unique to Technics which enables you to enjoy manual play, auto-start, auto-return, auto-stop, repeated performance from 1 to 6 times and continuous performance, and, in addition, multiple play, capable of playing 1 to 6 records continuously.

### ⑥ Highly Sensitive Gimbal Suspension System

With the high-precision pivot bearings employed for the horizontal and vertical journals of the tonearm, in concert with the adoption of the gimbal suspension system, a high-sensitivity arm of less than 7 mg friction has been attained, thus making it possible to fully realize the performance of high-compliance cartridges.

### ⑦ Independent Pitch Controls

Permits record speed (at both  $33\frac{1}{3}$  and 45 rpm) to be varied by up to 6%.

### ⑧ Precision Strobe Illuminator/Pilot Lamp

With the built-in strobe illuminator/pilot lamp, accurate speed adjustments can be made rapidly and easily.

### ⑨ Anti-Skating Force Mechanism

The well-designed anti-skating force mechanism ensures minimum side thrust with different cartridges and guarantees accurate center-of-the-groove tracking.

### ⑩ Detachable Dust Cover

## Specifications

### General

<b>Power supply:</b>	120V AC, 50 or 60 Hz
<b>Power consumption:</b>	3W
<b>Dimensions (W×H×D)</b>	43 × 17.6 × 37.5 cm (16-59/64 × 6-15/16 × 14-49/64 inches)
<b>Weight:</b>	4.8 kg (10.6 lb.)

### Turntable section

<b>Type:</b>	Frequency Generator Servo Automatic Turntable System (Auto-start, Auto-return, Auto-stop, "memo-gram" knob, Repeat and Manual play)
<b>Drive method:</b>	Belt drive
<b>Motor:</b>	Frequency Generator Servo DC motor
<b>Turntable platter:</b>	Aluminum die-cast, 30.4 cm (12")
<b>Turntable speeds:</b>	33-1/3 and 45 rpm
<b>Pitch controls:</b>	Individual adjustment controls, 6% adjustment range
<b>Wow and flutter:</b>	0.045% WRMS (JIS C5521) ±0.06% peak (IEC 98A Weighted)
<b>Rumble:</b>	-70 dB (IEC 98A Weighted)

### Tonearm section

<b>Type:</b>	Universal tubular arm, static-balanced type
<b>Effective length:</b>	230 mm (9-1/16")
<b>Overhang:</b>	15 mm (19/32")
<b>Friction:</b>	Within 7 mg (horizontally and vertically)
<b>Effective mass:</b>	13 g (without cartridge)
<b>Tracking error angle:</b>	Within 2°32' (at the outer groove of 30 cm (12") record) Within 0°32' (at the inner groove of 30 cm (12") record)
<b>Offset angle:</b>	22°
<b>Adjustable stylus pressure range:</b>	0 to 3 g (stylus pressure direct reading type)
<b>Cartridge weight range:</b>	5.5 to 8.5 g 14.5 to 17.5 g (including headshell)
<b>Headshell weight:</b>	9 g

### Cartridge section (for SL-235A)

<b>Type:</b>	Moving magnetic stereo cartridge
<b>Frequency response:</b>	20 to 25,000 Hz
<b>Output voltage:</b>	2.5 mV, 1 kHz, 5 cm/sec. zero to peak lateral velocity (3.5 mV, 1 kHz, 5 cm/sec. zero to peak 45° velocity)
<b>Channel separation:</b>	22 dB at 1 kHz
<b>Channel balance:</b>	Within 2 dB at 1 kHz
<b>Load impedance:</b>	47 kΩ to 100 kΩ
<b>Stylus pressure:</b>	1.75 ± 0.25 g
<b>Replacement stylus:</b>	EPS-74STSD (ATN71)

Panasonic Company  
Division of Matsushita Electric  
Corporation of America  
One Panasonic Way, Secaucus,  
New Jersey 07094

Panasonic Hawaii, Inc.  
320 Waiakamilo Road, Honolulu,  
Hawaii 96817

Printed in Japan

SFNU235M01  
S0478A1